



Welcome

Manual Instruction

- The User Manual corresponds to infotainment version V5.4. On the central control screen, you can tap “ → **General**” to view the current system version. If the system version is not up to date, please update it promptly.
- Descriptions marked with “*” in this manual are only applicable to certain configurations. Your vehicle may not be equipped with these features.
- The vehicle supports over-the-air (OTA) updates, and vehicle functions are regularly optimized or updated. The content of this manual will also be updated periodically.
- This manual provides information on all configurations of the model. Due to differences in vehicle configurations, software versions, etc., there may be discrepancies with the vehicle purchased. Please refer to the actual vehicle.
- Please read the warnings and cautions in the manual carefully:
 - ▲ **Warning Information:** Must be complied with to avoid personal injury or traffic accidents!
 - ▲ **Caution Information:** Must be complied with to avoid vehicle damage or faults!
 - i **Prompt Information:** These help you utilize the vehicle better.
- The illustrations in this manual are for the purpose of explaining functionality and are for reference only.



- Illustrations in the manual are annotated with:
 - ➡ indicates the object described.
 - ⇒ indicates the direction of sliding operations.
 - ↻ indicates the direction of rotation operations.
 - ↺ indicates the direction of flipping operations.

No individual or organization is allowed to copy or modify the contents of this manual, in whole or in part, without authorization from XPENG. XPENG reserves the right to modify, supplement, or terminate the content of this manual and the technical specifications at any time.

Reminder

To ensure your safety, please adhere to local laws and regulations while driving, and follow these important tips:

- While driving, drivers should follow traffic regulations, manage vehicle speed, and avoid speeding or driving with excess load.
- All drivers and passengers must wear seat belts at all times when the vehicle is running.
- Before driving, make sure all doors, the hood, and the trunk are closed, and verify the vehicle is in optimal condition with all functions operating safely.



- Stay alert when driving and do not drive under the influence of alcohol or when fatigued, as this can compromise vehicle control and lead to accidents, resulting in injury or death.
- Exercise caution when driving by assessing if the weather and road conditions are suitable and remain aware of other vehicles and pedestrians to make quick decisions and prevent accidents.
- Avoid using handheld devices for calls or checking messages while driving, as this can distract you and impair your vehicle control.



Appearance

Introduction

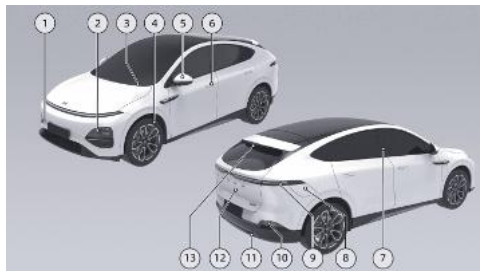

1. Tow Hook Cover
2. Head_Lamp
 - Width lights, low beam, high beam [See 235 page](#)
 - Intelligent High Beam(IHB) [See 235 page](#)
3. Front Wiper [See 238 page](#)
 - Wiper Operation [See 238 page](#)
4. Tires
 - Wiper Blade Replacement [See 336 page](#)
5. Exterior Rearview Mirrors
 - Exterior rearview mirror adjustment [See 231 page](#)
 - Page Display
6. Doors
 - Unlock/Lock Feedback [See 193 page](#)
 - Keyless Entry [See 205 page](#)
 - Open/Close, Emergency Open/Close [See 19 page](#)
 - Hidden Electric Door Handle [See 209 page](#)
7. NFC Card Swiping Area
8. Charging Port
 - Charging Port Cover Open/Close [See 312 page](#)
9. Taillight



- 10. Brake Lamp & Rear Reflex Reflector
- 11. Left rear fog lamp & Reversing lamp
- 12. Trunk
 - Open/Close, Opening Angle, Emergency Open/Close [See 19 page](#)

- 13. Rear Wiper
 - Wiper Operation [See 238 page](#)
 - Wiper Blade Replacement [See 336 page](#)

Introduction

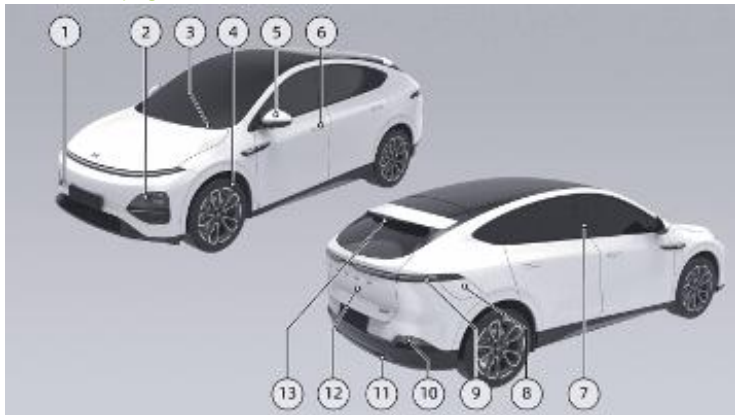

1. Towing hook cover

2. Headlight



- Position lights, low beams, and high beams [See 235 page](#)
 - Intelligent high beams [See 253 page](#)
3. Front wipers
 - Wiper operation [See 238 page](#)
 - Replacement of wiper blades [See 336 page](#)
 4. Wheels
 - Tire maintenance [See 341 page](#)
 - Tire specifications [See 375 page](#)
 5. Side Mirrors
 - Side Mirror Adjustment [See 231 page](#)
 - Side Mirror Heating [See 263 page](#)
 6. Doors
 - Unlocking and locking feedback [See 193 page](#)
 - PEPS [See 205 page](#)
 - Open or close, and emergency open or close [See 19 page](#)
 - Hidden electric door handle [See 209 page](#)
 7. NFC card scanning area
 8. Charging port cap
 - Opening and closing of charging port cap [See 312 page](#)
 9. Taillight
 10. Brake lights and rear reflective elements
 11. Rear fog lights or reversing lights
 12. Trunk
 - Open/close, opening angle, emergency open/close [See 19 page](#)
 13. Rear wiper
 - Wiper operation [See 238 page](#)
 - Replacement of wiper blades [See 336 page](#)



Front

Introduction

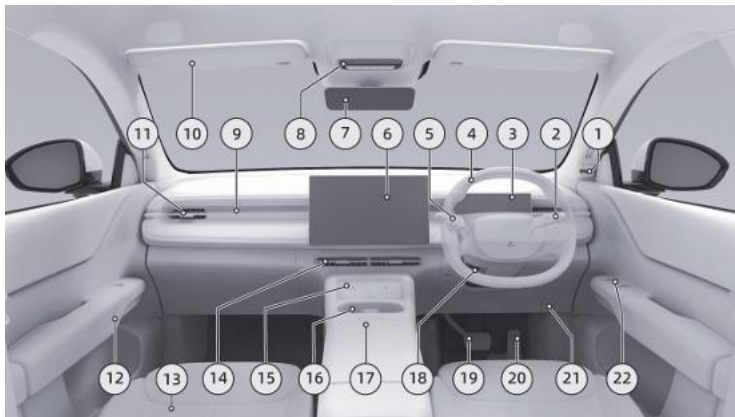

1. In-car camera

- Driver State Monitoring(DSM) [See 158 page](#)

2. Shift lever

- Gear Shifting Operation [See 240 page](#)
- Adaptive Cruise Control(ACC) [See 101 page](#)



- Lane Centering Control(LCC) [See 107 page](#)
- 3. Instrument Cluster
 - Instrument interface & Instrument indicator light [See 28 page](#)
- 4. Steering Wheel
 - Steering wheel buttons, horn [See 272 page](#)
 - Driver front airbag [See 173 page](#)
 - Power Steering [See 251 page](#)
- 5. Light & Wiper Lever
 - Lamp Operation [See 235 page](#)
 - Wiper Operation [See 238 page](#)
- 6. CID
 - CID interface [See 39 page](#)
- 7. Interior Rearview Mirror
 - Manual anti-glare interior rearview mirror [See 256 page](#)
 - Streaming Media Inside the Rearview Mirror [See 257 page](#)
- 8. Dome Light
 - Reading Light [See 282 page](#)
 - Hazard Warning Lights [See 352 page](#)
 - E-call* [See 368 page](#)
 - Emergency power off* [See 220 page](#)
- 9. Ambient Lights [See 283 page](#)
- 10. Sun Visor and Vanity Mirror [See 279 page](#)
- 11. Passenger side air conditioning vents
 - Manual adjustment [See 270 page](#)
- 12. Electric Door Open/Close [See 211 page](#)
- 13. Front row
 - Seat Adjustment [See 224 page](#)
 - Seat Ventilation [See 285 page](#)
 - Seat Heating* [See 284 page](#)
 - Seat Massage* [See 286 page](#)
- 14. Front central air conditioning vents
 - Manual adjustment [See 270 page](#)
- 15. Wireless Charging [See 289 page](#)



16. Cup holder [See 295 page](#)
17. Center Armrest Switch
18. Steering wheel unlock handle
 - Steering wheel position adjustment [See 255 page](#)
19. Brake Pedal
 - Pedal feel adjustment [See 243 page](#)
20. Accelerator Pedal
 - Regeneration [See 250 page](#)
21. Frunk Lid Open Handle [See 327 page](#)
22. Door Switch Pack
 - Power Window Switch [See 275 page](#)
 - Door lock switch [See 207 page](#)



Introduction

2

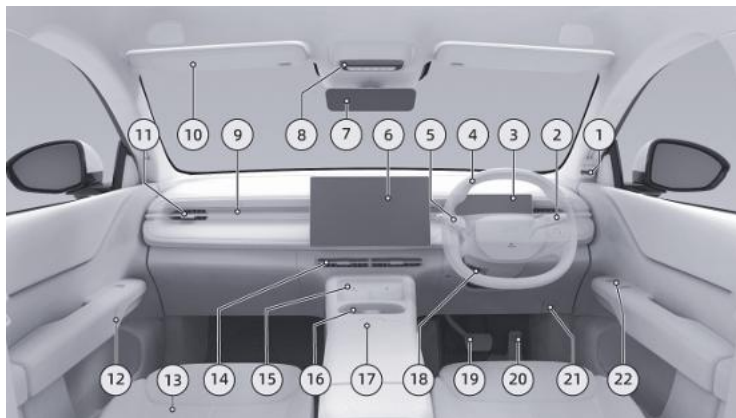

1. Interior camera
 - Driver status monitoring [See 158 page](#)
 - Lane Centering Control [See 107 page](#)
2. Gearshift lever
 - Gearshift operation [See 240 page](#)
 - Adaptive Cruise Control [See 101 page](#)
3. Instrument cluster
 - Dashboard interface, dashboard indicator light [See 28 page](#)
4. Steering Wheel



- Steering wheel key, horn [See 272 page](#)
 - Driver frontal airbag [See 170 page](#)
 - Power steering adjustment [See 251 page](#)
5. Lighting & wiper lever
- Lighting operation [See 235 page](#)
 - Wiper operation [See 238 page](#)
6. Central control screen
- Central control screen interface [See 33 page](#)
7. Interior rearview mirror
- Manual anti-glare [See 256 page](#)
 - Streaming Rearview Mirror* [See 257 page](#)
8. Front dome light
- Reading light [See 282 page](#)
 - Hazard warning light [See 352 page](#)
 - E-call* [See 368 page](#)
 - Emergency power off [See 220 page](#)
9. Ambient lights [See 283 page](#)
10. Sun visor and vanity mirror [See 279 page](#)
11. Front passenger's side A/C air vent
- Manual adjustment [See 270 page](#)
12. Electric door release switch [See 211 page](#)
13. Front seats
- Seat adjustment [See 224 page](#)
 - Seat ventilation [See 285 page](#)
 - Seat heating [See 284 page](#)
 - Seat massage* [See 286 page](#)
14. Front central A/C air vent
- Manual adjustment [See 270 page](#)
15. Wireless phone charging [See 289 page](#)
16. Cup holder [See 298 page](#)
17. Front central armrest box switch
18. Steering wheel unlocking handle
- Steering wheel position adjustment [See 255 page](#)
19. Brake pedal
- Pedal feel adjustment [See 243 page](#)



20. Accelerator pedal

- Regeneration [See 250 page](#)

21. Front hood release handle [See 327 page](#)

22. Door switch set

- Window switch [See 275 page](#)
- Door lock switch [See 207 page](#)



Rear

Introduction



1. Ceiling handle
2. Rear reading lights [See 282 page](#)
3. Rear center armrest
 - Backrest adjustment, backrest reclining [See 224 page](#)
 - Seat Heating* [See 284 page](#)
4. Rear seats
5. Door emergency opening ring [See 211 page](#)

Vehicle Profile



6. Door electric release switch [See 211 page](#)
7. Window switch [See 275 page](#)
8. Driver and passenger seat back map pocket
[See 295 page](#)
9. Type-C charging port [See 292 page](#)
10. Air conditioning outlet
 - Manual adjustment [See 270 page](#)



Introduction



1. Roof handle
2. Rear reading light [See 282 page](#)
3. Rear central armrest
4. Rear seats
5. Emergency door release pull handle [See 211 page](#)
6. Electric door release switch [See 211 page](#)
7. Backrest adjustment, backrest folding [See 224 page](#)
8. Seat heating* [See 284 page](#)
9. Emergency door release pull handle [See 211 page](#)
10. Electric door release switch [See 211 page](#)

Vehicle Profile



7. Window switch [See 275 page](#)
8. Driver/passenger backrest map pockets [See 298 page](#)
9. Type-C charging interface [See 292 page](#)
10. A/C air vent
 - Manual adjustment [See 270 page](#)



Trunk

Introduction



1. Trunk lid
 - Trunk emergency device [See 352 page](#)
2. Trunk interior switch
3. Trunk exterior switch
 - Opening/closing of trunk [See 214 page](#)
4. Rear trunk light
 - Opening/closing of trunk [See 214 page](#)



5. Trunk maintenance cover plate
 - Charge port emergency unlocking [See 319 page](#)
6. 12 V power port [See 292 page](#)
7. Trunk cargo shade [See 294 page](#)



Front trunk

Introduction

2



1. Front trunk fuse box
2. Windshield washer fluid reservoir
 - Inspection and refilling [See 334 page](#)
 - Filling amount [See 382 page](#)
3. Brake fluid reservoir
 - Inspection and refilling [See 331 page](#)
 - Model and filling amount [See 382 page](#)
4. Battery



5. Coolant reservoir

- Inspection and refilling [See 329 page](#)
- Model and filling amount [See 382 page](#)



HV components

Introduction

2

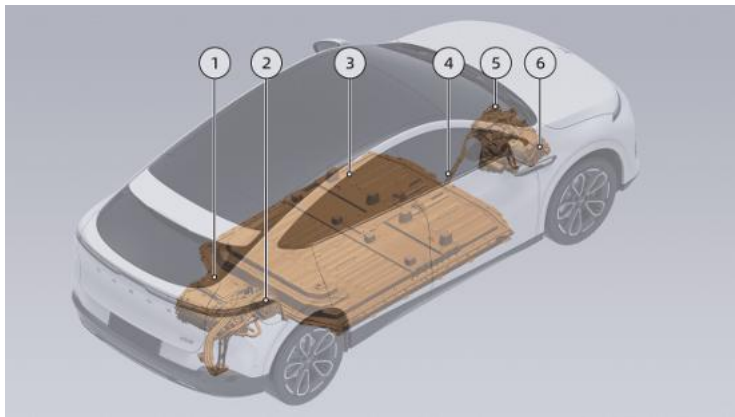

1. Rear electric drive system

- Type and parameters [See 378 page](#)

2. Charging port

- Opening and closing of charging port cap [See 312 page](#)
- Charging operation [See 316 page](#)



- Charge port emergency unlocking [See 319 page](#)
 - External discharge [See 324 page](#)
3. Traction Battery
- Traction battery maintenance [See 338 page](#)
- Recycling requirements and procedures of traction battery [See 387 page](#)
4. HV harness
 5. Air compressor processor
 6. Front electric drive system*



warning

Do not touch or remove the high voltage harness or the high voltage components connected to the high voltage harness, or there is a risk of electric shock.



Intelligent driver assistance-hardware

Radar

2

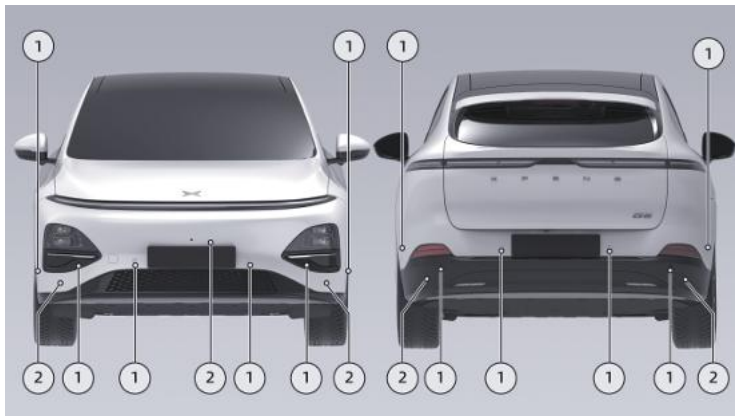

- 1. Ultrasonic radar
- 2. Millimeter wave radar*



Camera

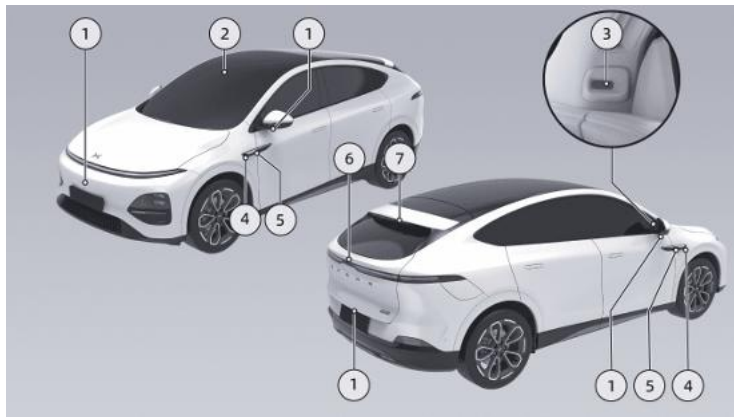

- 1. Surround-view camera
- 2. Intelligent front binocular camera
- 3. Driver Status Monitoring (DSM) camera*
- 4. Front camera*
- 5. Back camera*
- 6. Back camera*
- 7. CMS Inside Mirror Camera*



warning

With limited radar and camera functionality, the Driving Aids feature will not be switched on or will function normally.

Instrument Display

Indicators on Dashboard

After the vehicle is powered on, some indicators will illuminate. After the system completes self-inspection, these indicators will go out if the system is normal. Some indicators illuminate to display the current status of vehicle system functions, not a system fault. If there is anything unclear in the daily use of the vehicle, please consult the XPENG Service Center.

3



High beams on



SRS fault



Intelligent high beams on and the high beams on



Driver seat belt unfastened



Intelligent high beam fault



Front passenger seat belt unfastened



Intelligent high beams on and the high beams not on



Rear left passenger seat belt unfastened



















Left turn signal on



















Rear middle passenger seat belt unfastened



	Right turn signal on		Rear right passenger seat belt unfastened
	Low beams on		Speed limit on the speed limit sign
	Rear fog lights on		Speed limit of the electronic eye
	Clearance lights on		HV system ready and the vehicle in a drivable status
	Automatic headlight control on and the low beams on		Battery fault
	Lane Departure Assist fault		Drive power limit
	Charging cable connected		Powertrain fault
	Timed charging ON		Motor and controller overheating



	Steering system fault		Motor and controller fault
	Steady on: Parking function activated		Traction battery temperature too low
	Flashing: Incorrect caliper status		Traction battery temperature too high
	Steady on: parking brake fault		Traction battery SOC too low
	Flashing: Parking system in maintenance mode		Traction battery fault
	AUTO HOLD activated		Traction battery disconnected
	AUTO HOLD fault		Forward Collision Warning fault
	Brake system fault		
	Flashing: Electronic Stability Program activated		
	Steady on: Electronic Stability Program fault		



Electronic Stability Program OFF



Forward Collision Warning OFF



Anti-lock Braking System fault



Too many indicators are lit at the same time, and all the indicator display positions are occupied.



Braking performance degradation



Driver assistance system fault



HDC activated



Tire pressure abnormal or Tire Pressure Monitor System fault



HDC fault



Any door(s), front hood and/or trunk not closed



No speed limit sign



Lane Centering Control activated



Maximum speed limit of ACC/LCC, and any function activated



Lane Centering Control can be activated



Maximum speed limit of ACC/LCC, and both not activated



Intelligent Parking Assist activated



LCC malfunction indicator lamp



Intelligent Parking Assist can be activated



Indicator for towing function not activated*



Adaptive Cruise Control activated



Towing malfunction indicator lamp*



Adaptive Cruise Control can be activated



Normal towing function indicator*



Adaptive Cruise Control unavailable



Speed Assistance System activation



Exceed the speed limit on the speed limit sign



Intelligent Navigation Guided Pilot not available



Intelligent Parking Assist unavailable



Lane Centering Control unavailable



Low washer fluid level indicator



Central Control Screen

Page Display

The central control screen displays the split screens by default. The Map Navigation interface is displayed on the left, and the Real-time Virtual Reality Assist interface on the right.

3

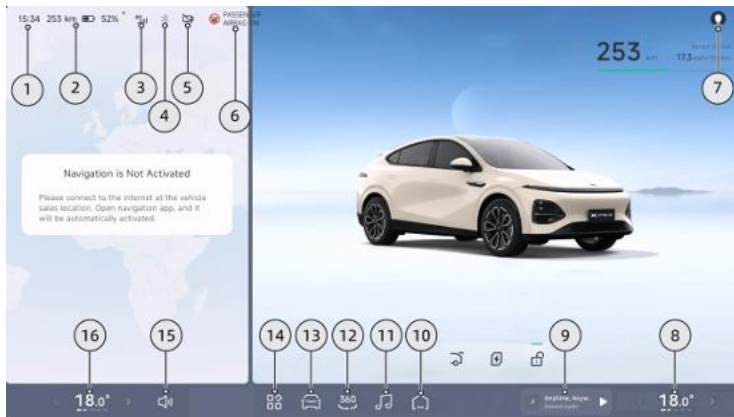



1. Time
2. Traction Battery
 - It indicates the current driving range and SOC.
3. Network
4. Bluetooth
5. Driving Recorder
 - Display the current status of driving video recording [See 94 page](#).
6. Passenger airbag disable switch
7. Account & Preferences [See 66 page](#)
 - Tap Login to display the account avatar.
 - Set vehicle use habits.
8. Driver's seat A/C components
 - It indicates the current temperature and air volume of the driver's seat A/C.
 - Tap to adjust the A/C [See 263 page](#).
9. Music components [See 69 page](#)
 - It displays the currently playing media cover, media name, and play source.
 - Tap to pause or resume music playing.
 - Swipe left or right to play the previous or next song.
10. Homepage
 - Tap to return to the homepage.
11. Music [See 69 page](#)
12. 360 camera [See 85 page](#)
13. Settings
 - Access to vehicle control setting.
14. App Center
15. Volume adjustment
16. Front passenger's seat A/C components
 - It indicates the current temperature and air volume of the front passenger's seat A/C.
 - Tap to adjust the A/C [See 263 page](#).

i Tips

The font used by XOS is [MiSans].



Split-screen Multitasking

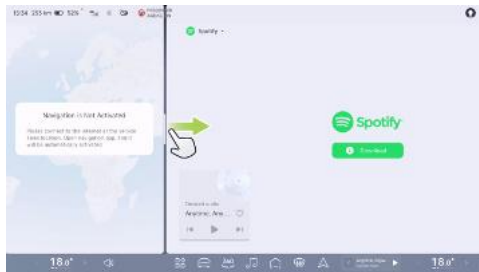

Drag the split screen line to switch between full screen and split screens, and change the window size for the split screen. When the split screen is switched to full screen, the last opened app with split screen will be memorized.

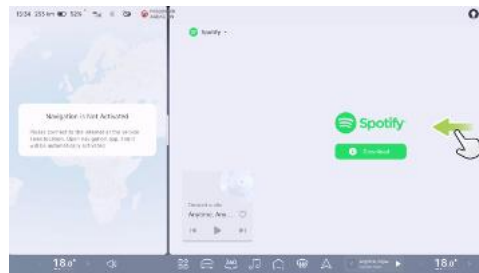

Slide to return to the previous page of the corresponding window.

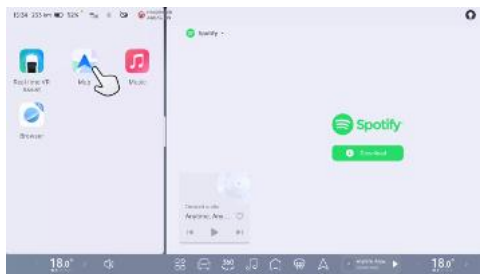
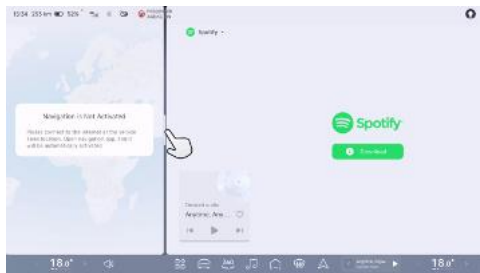

Tap the split screen line to fix the small window mode. In the small window, Real-time Virtual Reality Assist, Map, Music, and Browser can be displayed.

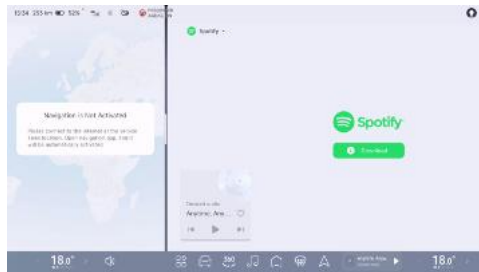

In the split screen mode, different apps can be opened in large windows, allowing, for example, the driver to view the navigation interface and the front passenger to watch videos, listen to music and read lyrics simultaneously.



Gesture Interaction

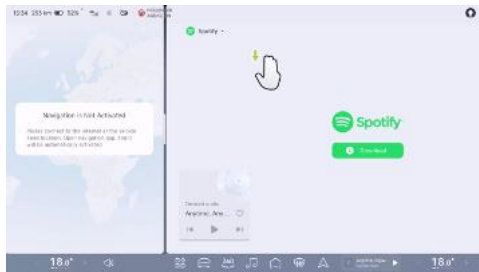

Three-finger swiping down allows exiting the app opened in the large window in the split screen mode and then returning to the corresponding homepage.

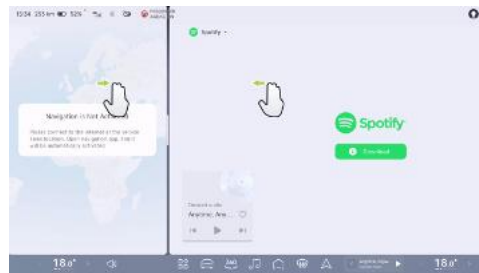



Three- or four-finger swiping left or right allows a switch between different app windows. However, it does not work in full screen mode.

i Tips

The bottom taskbar area does not participate in gestures. The status bar and the bottom taskbar are not hidden during the swap.

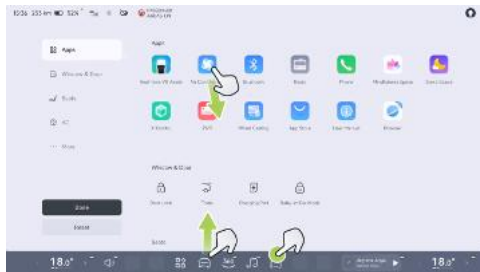
Customize Bottom Taskbar



1. To customize the bottom taskbar, press and hold any area of the bottom taskbar icon.
2. You can drag the function control and shortcut component icons in Apps, Window & Door, Seats, and A/C to the blank at the bottom taskbar.
3. In the Custom status, tap  in the upper right corner or drag the icon to the App Center and release to remove the icon from the bottom taskbar.

4. Tap **“Done”** or tap the blank space on the bottom taskbar to exit the custom status.

App Center

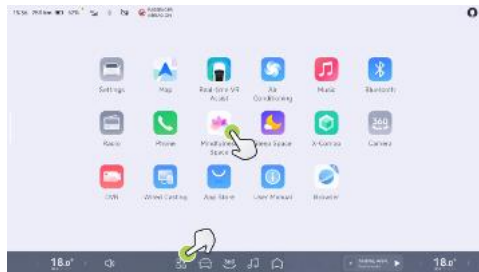

1. On the bottom taskbar, tap the  icon to open the App Center, and tap any blank space in the App Center to exit quickly.
2. Tap the app icon to open the app. Apps being downloaded and installed also have corresponding status display.
3. Tap and hold the app icon or blank space to enter the custom App Center status. At this



time, you can drag the icon to sort in the app list.

Shortcut Panel

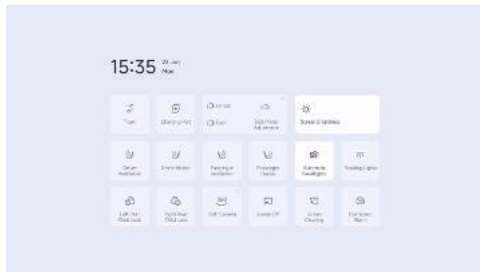

For high-frequency functions, you can operate directly from the shortcut panel without opening the app. Swipe down from the top of the screen to unfold the shortcut panel, and swipe up to fold it. The shortcut panel is folded when you tap on a blank space or open a new screen.

Page Display

The central control screen displays split screen status by default. The map navigation interface is displayed on the left, and the global intelligent driving interface is displayed on the right.

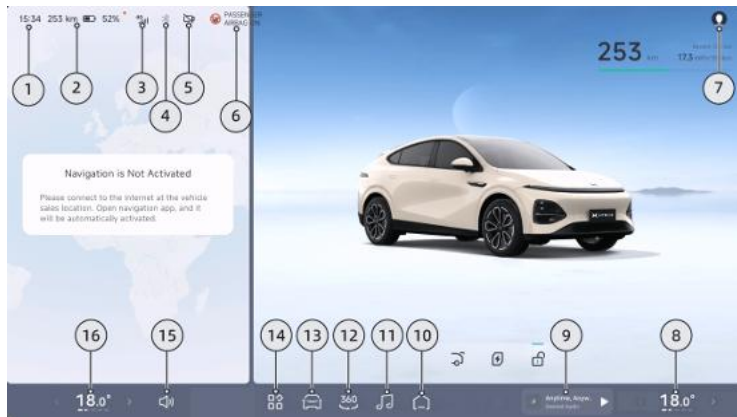



1. Time
2. Power Battery
 - Displays the current cruising range and remaining battery power.
3. Network
4. Bluetooth
5. Driving Recorder*
 - Display the current driving video status [See 94 page](#).
6. Passenger airbag disable switch
7. Account & Habits [See 66 page](#)
 - Click Login to display the account avatar.
 - Set car usage habits.
8. Driver air conditioning components
 - Displays the current temperature and air volume status of the main driver's air conditioner.
 - Click to adjust air conditioning [See 267 page](#)
9. Music Components [See 69 page](#)
 - Displays the cover, name, and source of the currently playing media.
 - Click to pause or resume music playback.
 - Swipe left or right to go to the previous or next song.
10. Homepage
 - Click to return to the desktop.
11. Music [See 69 page](#)
12. 360°Around View Monitoring(AVM) [See 85 page](#)
13. Setting
 - Vehicle control settings entrance.
14. Application Center
15. Volume Control
16. Passenger air conditioning components
 - Displays the current temperature and air volume status of the passenger side air conditioner.

- Click to adjust air conditioning [See 267 page](#)

The font used by XOS is [MiSans].

Display Settings

Brightness adjustment



On the central control screen, go to “ → **Display**” interface, and you can adjust the touchscreen and instrument display brightness using the sliders.

Display mode

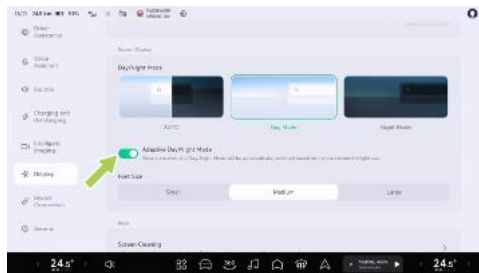

On the central control screen, go to “ → **Display**” interface, and you can switch between Automatic, Day Mode, and Night Mode. You can also turn on or off “**Adaptive Day/Night Mode**”. After turning it on, it will automatically switch to Day/Night Mode according to the ambient light.



Standby Mode



On the central control screen, go to “ → **Display**” interface, and you can enter “**Standby Mode**”. In “**Standby Mode**”, the headlights, touchscreen, and dashboard will be turned off.

Voice Assistant

Introduction

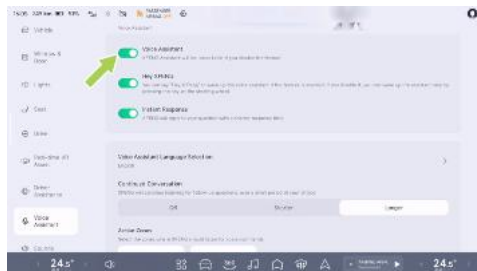

On the central control screen, go to “ → **Voice Assistant**” interface, and you can enable “**Voice Assistant**”. This feature supports enabling functions such as “**Hey XPENG** and **Instant Response**”.

Only after “**Voice Assistant**” is turned on, can other Voice Assistant functions be enabled.

Wake-up mode

Xpeng can be woken up in the following ways:

- Voice button on steering wheel
- “Hey XPENG”

On the central control screen, go to “ → **Voice Assistant**” interface, and you can turn on or off “**Hey XPENG**”. After the function is enabled, add “**Hey XPENG**” before or after a command to initiate the Xpeng service at any time. For example:

- Hey XPENG, turn on the A/C.
- Navigate home, Hey XPENG.
- How long will it take to reach the destination? Hey XPENG.
- Hey XPENG, play a song.

Voice Assistant Language Selection

On the central control screen, go to “ → **Voice Assistant**” interface and tap “**Voice Assistant Language Selection**”. You can select the language of Voice Assistant, download and

install a new language package, and switch to a new language.

i Tips

- Currently the voice pack supports English, German, French, Thai and Cantones
- Only the English voice pack supports the continuous conversation capability

Dialogue mode

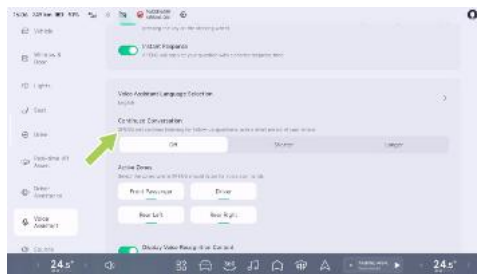



On the central control screen, go to “ → **Voice Assistant**” interface, and you can select "Off", "Shorter", or "Longer".

- Off: The dialogue mode will be turned off after the option is selected.
- Shorter: After the option is selected, only one command can be executed by the Xpeng for each dialogue.
- Longer: After the option is selected, Xpeng can keep listening for a period of time after executing the previous task. At this time, Xpeng can directly issue new commands without the need to repeatedly wake up it.

Activate Zones

The Voice Assistant supports the two-row four-zone voice dialogue recognition of the vehicle, and each passenger in the vehicle can wake up Xpeng at any time to have a dialogue. Through the sound source positioning and voice separation capability of the six voice recognition zones, Xpeng can accurately distinguish which position gives commands and

provides corresponding services. The dialogue between passengers does not interfere with each other.

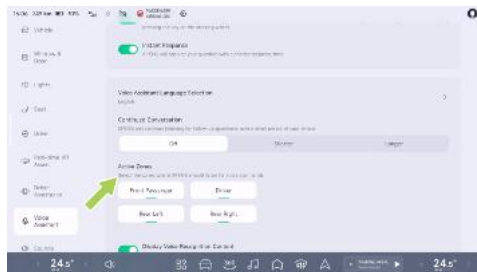

3

On the central control screen, go to “ → **Voice Assistant**” interface, and you can close the voice recognition zone. After closing, the system will no longer accept voice commands from this voice recognition zone.

Internet-free Dialogue

In poor network environments such as underground garage, expressways and tunnels,

some conversational services that rely heavily on the Internet (such as playing music) are temporarily unavailable. However, Xpeng can still provide you with basic voice services, including but not limited to the following functions:

- Voice control for A/C
- Voice control for seats
- Voice control for doors and windows
- Voice control for lighting
- Voice control for navigation

Join the XPENG Assistant User Experience Improvement Program

In order to make Xpeng smarter and smarter, we sincerely invite you to join the “**XPENG Assistant User Experience Improvement Program**”.

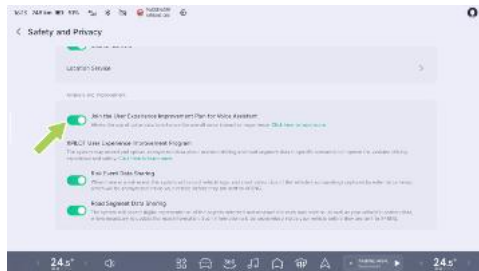

On the central control screen, go to “ → **General** → **Safety and Privacy**” interface, and you can turn on or off “**Join User Experience Improvement Plan for Voice Assistant**”.

Before enabling this function, you need to review and agree with the XPENG Assistant User Experience Improvement Program. After this function is enabled, the system can collect voice usage information to improve your voice interaction experience.



Voice control

Voice Control allows the driver to control the vehicle's features while driving. Please using

voice commands to avoid distractions and improve driving safety and convenience.

Common voice control commands (English)

Category	Function	Sample voice control commands
----------	----------	-------------------------------



Vehicle	Seats	Raise driver seat higher
		Move driver seat back to the front
		Activate driver's seat massage
		Change second row seat massage mode
		Turn on front massage to low
	AC	Turn on AC
		Driver ac temperature turn higher
		Turn on driver auto ac
		Turn on purifier
		Turn on recirculation
		Turn on max cooling
		Turn on max heating
		Turn on refresh mode
		Open seat ventilation
48		



Phone	/	Make a call
		Call Anna
		Call back
Navigation	/	Navigate to
		Exit navigation
		Take me home
Media	/	Next song
		Pause
		Turn off music
		Play music



Others	Screen	Turn up main screen brightness by 10%
		Dashboard brighter
		Change to day mode
	Device	Turn on driver Bluetooth
		Turn on the Wi-Fi
		Turn on camera

Gängige Sprachsteuerungsbefehle (Deutsch)

Category	Function	Sample voice control commands
----------	----------	-------------------------------



Fahrzeug	Sitz	Verstelle den rechten Rücksitz nach vorne
		Neige die Rückenlehne des Fahrers nach vorne
		Aktiviere die Sitzmassage des Fahrers
		Aktiviere wave Massage des Vordersitzes
		Stelle die Massageintensität auf Stufe hoch ein
	Klimaanlage	Schalte die Klimaanlage des ganzen Fahrzeugs aus
		Senke die Temperatur auf der Beifahrerseite
		Erhöhe den Luftstrom
		Stelle Klimaanlage auf Automatikmodus ein
		Reinige die Luft
		Schalte die Umluft aus



Telefon	/	Mache einen Anruf
		Rufe Anna
		Rufe 101
		Rufe zurück
Navigation	/	Wo ist die Seite für Klimaanlage
		Schalte Navigation aus
		Bringe mich nach Hause
Media	/	Vorheriges Lied
		Pausiere
		Spiele Musik
		Schalte Sotify ein



Sonstiges	Bildschirm	Erhöhe die Bildschirmhelligkeit um 20%
		Erhöhe die Heiligkeit des Armaturenbrettes
		Erhöhe die Bildschirmhelligkeit des Armaturenbretts
	Geräteverbindung	Schalte Bluetooth ein
		Schalte 360° Kamera aus

Commandes de contrôle vocal courantes (français)

Category	Function	Sample voice control commands
----------	----------	-------------------------------



Véhicule XPENG	Sièges	Monte le siège passager
		Incline le dossier du siège conducteur vers l'avant
		Active le massage, s'il te plaît
		Donne-moi un autre type de massage
		Active le massage du siège conducteur à faible intensité
	Climatisation	Allume toutes les climatisations
		Augmente la température de la climatisation
		Accrois le volume d'air
		Active la climatisation automatique du conducteur
		Ferme le purificateur d'air
		Active la recirculation de l'air
		Arrête le dégivrage
		Refroidissement max
		54



Téléphone	/	Passé un appel téléphonique
		Appelle le service client
		Appeler 123
		Recompose
Navigation	/	Navigue vers
		Termine la navigation
		Rentrer à la maison
Média	/	La chanson précédente
		Arrête la diffusion de la radio
		Joue de la musique



Autres	Écrans	Augmente la luminosité de l'écran
		Tableau de bord plus lumineux
		Mets la luminosité du tableau de bord en mode automatique
	Appareils	Active le Bluetooth
		Active le WIFI
		Ouvre la caméra

คำสั่งควบคุมด้วยเสียงทั่วไป (ภาษาไทย)

หมวดหมู่	การทำงาน	ตัวอย่างคำสั่งควบคุมด้วยเสียง
----------	----------	-------------------------------



รถยนต์	เบาะ	ปรับเบาะนั่งไปข้างหลังน้อย
		ปรับพนักพิงหลังผู้โดยสารด้านหน้าไปข้างหลังสุด
		เปิดฟังก์ชันการนวดเบาะนั่งของคนขับ
		ปรับแรงนวดของเบาะคนขับให้สูงขึ้นนิดหน่อย
	เครื่องปรับอากาศ	ปิดเครื่องปรับอากาศทั้งคันรถ
		ปรับอุณหภูมิของที่นั่งคนขับสูงขึ้นเล็กน้อย
		เพิ่มความเร็วลมของเครื่องปรับอากาศในที่นั่งด้านหลัง
		เปิดการไล่ฝ้ากระจกหลัง
		ปิดการอุ่นเบาะของผู้โดยสารด้านหน้า
	ไฟ	ปิดไฟตัดหมอก
		เปิดไฟสร้างบรรยากาศ
		ตั้งไฟสร้างบรรยากาศเป็นสีแดง



โทรศัพท์	/	โทรศัพท์
		โทรหาผู้ติดต่อ
		โทร 123
		โทรหมายเลขเมื่อกี้
การนำทาง	/	นำทางไปที่
		ไปที่บ้าน
		นำทางไปบริษัท
สื่อ	/	รายการวิทยุก่อนหน้า
		เพลงถัดไป
		หยุดเล่น
		เล่นเพลง



อื่น	หน้าจอ	เปิดหน้าจอทั้งหมดในรถ
		ปรับหน้าจอให้สว่างขึ้น
		เปิดความสว่างอัตโนมัติของหน้าจอ ด้านหน้า
	อุปกรณ์	เปิดบลูทูธ
		เปิดกล้อง
		เปิดกล้องหน้า

Common voice control commands (Cantonese)

Classification	Function	Examples of voice control commands
----------------	----------	------------------------------------



Vehicle control XPENG	Seat	Adjust the driver's seat higher
		Adjust the driver's seat backrest forward
		Start the driver's seat massage
		Change the driver's massage mode
		Adjust the driver's massage to a lower intensity
	A/C cooling 60	Turn on the A/C for all seats
		Lower the temperature in the front seats
		Increase the A/C airflow
		Start automatic A/C control
		Turn on the air purification mode
		Turn on the fresh air mode
		Turn on the front defogging mode



Phone	/	Make a phone call
		Call Anna
		Redial
		Call back
Navigation	/	Navigate to
		Exit navigation
		Navigate to home
		Navigate to work
Media	/	Previous radio
		Play music
		Next song
		Stop playing



Others	Screen	Adjust screen brightness
		Turn up the brightness of dashboard
		Turn on the automatic brightness of dashboard
	Device connection	Turn on Bluetooth
		Turn on Wi-Fi
		Turn on the camera



X-Combo

Introduction

The X-Combo feature allows for individual customization of cabin functions based on your driving habits. For example, at lunchtime on weekdays when your vehicle is at the office, you can pre-activate the remote A/C to adjust the interior temperature, and upon entering the vehicle, the seat position is automatically adjusted for nap mode.

caution

To ensure the functional experience, it is recommended that the Xpeng Motors App be upgraded to version 2.34.0 or above. The vehicle system needs to be upgraded to version 5.4.5 or above

Vehicle End App

Function entry



On the central control screen, tap “”, and then tap “**X-Combo**” in the App Center to enter the X-Combo interface.

Select Combo

The X-Combo offers a selection of innovative and practical driving combos. You can select combos on the “**Recommended Store**” interface. Tap “**Combo Card**” to view its details. On the



central control screen, log in to your account and tap **“Add”** to include the combo in your collection. In the search box at the top right, you can search for Combo cards using Combo codes and keywords.

My Combos

On the central control screen, log in to your account, and you can enable, disable, delete, restore, or run combos.

Combo editing

The X-Combo supports custom editing of cards in My Combos.

1. On the central control screen, log in to your account, and on the My Combos interface, tap the Combo Card to access the card details.
2. Tap the  icon, and from the drop-down menu, select **“Modify Combo”**.
3. Use the XPENG App to search for a Combo code or scan the QR code for editing.

Tips

Changes to the scene require both the vehicle and the mobile phone to be connected to the network before the update can be synchronized.

3

Running view

The enabled combos will automatically perform one or more continuous functions when the vehicle meets the specified trigger conditions. You can tap **“X-Combo Running”** on the status bar at the top of the central control screen to view, stop, or restore the running combo.

Mobile App

Function entry

In the XPENG App, go to **“XPENG→X-Combo”** interface, and you can customize your own combos.



Select Combo

The X-Combo offers a selection of innovative and practical driving combos. You can select combos on the **“Recommended Store”** interface. Tap **“Combo Card”** to view its details. Tap **“+Add”** to include the combo in My Combos. You can also adjust the combo using the **“Customize”** button according to your driving habits. In the search box at the top right, you can search for Combo cards using Combo codes and keywords.

Tips

Changes to the scene require both the vehicle and the mobile phone to be connected to the network before the update can be synchronized.

Personalized customization

The X-Combo supports individual customization of cabin features. Tap **“X-Combo→→Create a combo”** to begin personal customization.

The system offers two trigger methods for combo execution: **“In-vehicle”** and **“Remote”**. It

supports various automation triggers, including voice commands, time, environment, vehicle status, and more. Users can set up a wide range of execution actions, such as driving mode adjustments and A/C settings.

Through the **“Advanced”** option, you can set additional advanced application combos, such as multi-condition continuous sensing, multi-task synchronous execution, and delayed instruction execution.

caution

- Always keep the vehicle and personnel safe while the scenario is running.
- It is recommended to “select **“Intelligent Query”** Mode when creating Combos. The combo task will then determine the level of safety of the combo based on the state of the vehicle before it is carried out at the end of the vehicle, if there is a road safety risk (e.g. adjusting the driving mode in D). A Xpeng smart recommendation card in the CID will be used to ask if the combo is to



be executed if “do not query”, The combo is performed immediately when the trigger condition is met, be aware of the associated security risks.

User Account

Account Type

Owner Account

Download the XPENG App, and log in with your phone number to complete account registration. If you wish to use all vehicle functions (for example, account memory), please complete the vehicle account binding.

After purchasing the vehicle, during the handover process, the first account bound and activated will be the owner's account. A vehicle can only be bound to one owner account, but one account can bind multiple vehicles.

Family and Friend Accounts

After logging into the XPENG App, as the vehicle owner, you can tap “**XPENG**→**Settings**→**Vehicle Authorization**→**Add**”, enter the phone number of the person you want to authorize, and set the validity period as needed. In this way, you can share the vehicle's access rights with your family and friends. After logging into the XPENG App, the authorized user can create a Bluetooth key or use remote vehicle control features. Up to 5 family and friends can be authorized to use the vehicle.

You can open the XPENG App, go to the “**Vehicle Authorization**” interface to view or manage the authorized users. After finding the user you want to deauthorize, tap “**Deauthorize**”. Then the user's authorization is canceled.

Visitor Mode

Visitor mode: This is the mode when the vehicle account is not logged in. In this mode, only functions without account permission restrictions



(e.g., A/C, seat heating, and seat massage*) are accessible.

Login Account

When multiple people share one vehicle, logging into the corresponding account will automatically adjust the seat, side mirror position, and other settings for the user. You can log in to your account by any of the following methods:

- Log into the XPENG App on your phone. When unlocking the vehicle with a Bluetooth key, the user account will be automatically logged in.
- Tap the default gray avatar (not logged in) in the upper left corner of the central control screen, and scan the QR code to log in after logging into the XPENG App on your phone.

Account Memory

Once you log into your account, you can save personal driving preferences such as seat and side mirror positions*. Each account can store up to six driving preferences. After selecting your profile picture on the central control screen, you

can swiftly choose the driving preferences you wish to activate for this session.

Tap “**Manage Habits**”, and you can delete or rename any saved driving preferences.

On-board Navigation

Seamless Navigation

Introduction

After you log in and bind with your mobile App, seamless navigation allows you to send an address to the vehicle from your mobile phone to start navigation promptly.

Operation

Taking the XPENG App as an example, seamless navigation can be realized through the following operations:

1. In the mobile App, switch to the “**XPENG**” interface, and tap “**Search for Charging Stations and Destinations**” to enter the Vehicle Positioning or Search Box interface.



On this interface, set the navigation destination.

2. Tap “**Send to Vehicle**” to send the destination information to the central control screen of the vehicle.
3. After the central control screen receives the navigation information sent by the mobile phone, a confirmation card will pop up. Tap “**OK**” to realize seamless navigation.

Charging Planning

For long-distance travel, the system can automatically plan driving and charging routes according to charging preference.

1. On the map interface of the central control screen, tap “**Map Settings**” to adjust the minimum SOC separately for arrival at the charging station and the destination in “**Charging Route Preference settings**”.
2. On the Route Planning interface, tap “**Charge**” to enter the Intelligent Charging Planning interface. The system will automatically

plan charging stations along the way, and display information such as charging station information, driving interval distance, recharging times and time length. Tap “**Start Navigation**” to start the journey.

i Tips

If the current power preference is sufficient to reach the destination, the charging station will not be added automatically.

3. During driving, the distance to charging station and estimated arrival time will be updated dynamically.



Music App

Introduction

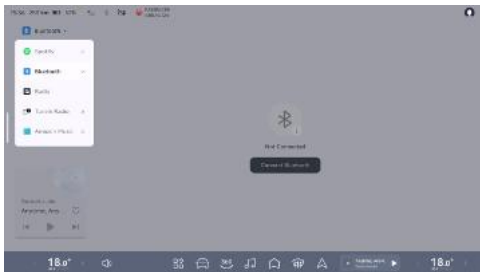

XPENG provides customized music apps, supporting audio sources such as Spotify, Radio and Bluetooth.

On the bottom taskbar of the central control screen, tap “🎵” to switch and play the audio source at the audio source entrance in the upper left corner of the music interface.

Radio

The vehicle supports local radio FM.

Switch the audio source to “**Radio**” to play local radio stations.

Bluetooth

Switch the audio source to “**Bluetooth**”, and tap “**Connect Bluetooth**” to connect the mobile Bluetooth. Then you can listen to songs from your mobile phone in the vehicle.

Wired Projection

Introduction

Enjoy wired projection functionality that allows you to project the screen from devices such as game consoles and computers (including Switch and MacBook) to the IVI central control screen for an unprecedented visual experience.



Operation



1. Tap the central control screen “” and tap “**Wired Casting**” in the app center.
2. Use an HDMI cable and video capture card to connect to the front row Type-C or Type-A interface.

Tips

The Switch requires an additional PD charging cable that plugs into a video

capture card or HDMI and connects to the C port on the vehicle end.

3. Once connected successfully, the image will be displayed on the screen.
4. Wired projection:
 - Swipe up or down on the left side of the screen to adjust the screen brightness.
 - Swipe up or down on the right side of the screen to adjust the media volume.
 - The unmute function is supported.
5. Tap the screen, tap “**Exit Mirroring**” on the upper left corner to exit the mirroring.

Tips

Due to Sony PS, Xbox, etc. require high voltage, it is not recommended to use the in-vehicle transfer port for projection. However, it is possible to use the outside power supply to power the device when parked.



Sound Setting

Introduction

On the central control screen, go to “ → Sounds” interface, and you can set vehicle sounds.

Volume adjustment

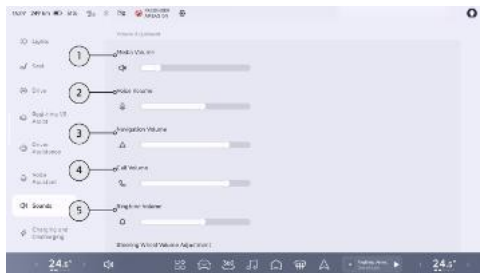

1. Adjust the media volume.
2. Adjust the voice announcement volume.
3. Adjust the navigation broadcast volume.

4. Adjust the call volume.
5. Adjust the ringtone volume.

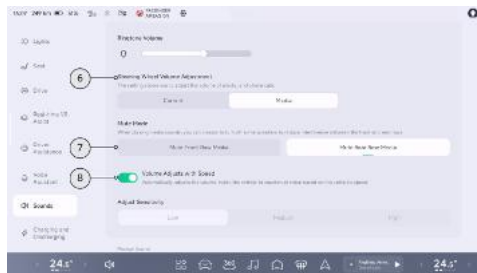

6. Steering wheel volume adjustment: Tap to set the type of volume adjustment controlled by the steering wheel scroll button.
7. Mute mode: Tap to mute the audio from either the front or rear media to reduce interference between front and rear passenger areas during media playback.
8. Volume adjustment with speed: Tap to enable automatic volume adjustment based on vehicle speed to counteract noise, or choose

different sensitivity levels to suit your driving habits.

Prompt sound

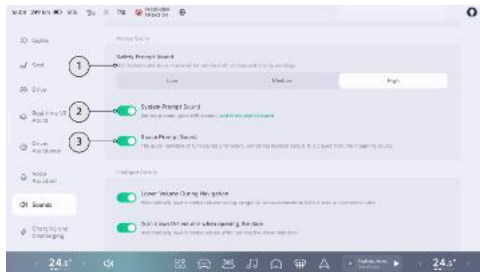

1. Safety prompt sound: Tap to set the prompt sound and volume levels for vehicle malfunctions and driving warnings.
2. System prompt sound: Once the system prompt sound is enabled, the key prompt sound, gear shift prompt sound, external charging plug prompt sound, and driving mode sound effects can be toggled on or off in **“and more prompt sound”**.

3. Spatial prompt sound: Once activated, prompt sounds indicating spatial cues, like turn signals and radar alerts, will originate from the respective trigger locations.

Intelligent control

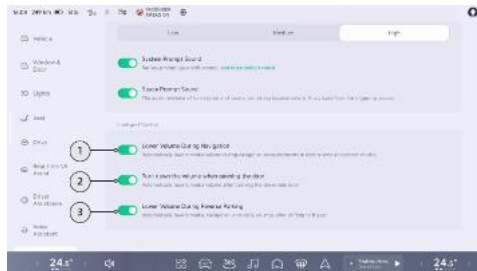

1. Volume reduction during navigation: After tapping to enable the feature, the media volume will automatically reduce during navigation playback in both shared and private modes.
2. Volume reduction when opening door: After tapping to activate the feature, the media



volume will automatically lower when the driver's door is opened.

3. Volume reduction during reversing: After tapping to activate the feature and shifting into R position, the volumes of media, navigation, and voice will automatically decrease.

Devices Connection

Introduction

You can connect the device via on-board Bluetooth, Wi-Fi, or the on-board hotspot.

Operation

Bluetooth

On the central control screen, go to “ → **Device Connection**” interface or tap the status bar at the top of the central control screen to turn Bluetooth on or off. After the “**Allow Detection**” function is turned on, other Bluetooth devices can detect the Bluetooth of this vehicle.

On the Bluetooth Device interface, you can select the mobile device to be paired and complete the pairing according to the interface prompts.

Once pairing is successful, you can confirm on your phone to synchronize communication data (such as contacts and call logs) from the mobile device to the vehicle. This makes it easier to answer and make calls, enhancing the on-board phone function experience. Music from your mobile phone can also be played through the vehicle's audio system.

Wireless network

On the central control screen, go to “ → **Device Connection**” interface or tap the status bar at the top of the central control screen. You can turn on or off the wireless network.

After enabling, the vehicle will automatically scan for wireless networks; you can select the desired network and input the password to establish a connection.



i Tips

- You can connect to and use personal hotspots shared by your phone through wireless networking, and be aware of traffic consumption when using.
- The signal strength of the currently connected network can be viewed from the wireless network icon in the status bar, if the signal strength is low, the vehicle may be slow to access the internet.

On-board hotspot

On the central control screen, go to “ → **Device Connection**” interface, and you can turn on or off the on-board hotspot and select the hotspot mode 5 GHz or 2.4 GHz.

You can use other mobile devices to search for the vehicle's on-board hotspot, and input the password to connect.

i Tips

It is recommended to choose the 5GHz band first, enabling the 2.4GHz band can be compatible with more devices, but network performance will be reduced.

System Update

Introduction

The vehicle can be updated remotely through central control screen or mobile App to obtain the latest functions. It is recommended that you update the system as soon as possible after receiving the new version prompt.

i Tips

- Make sure the vehicle is connected to the network and will not receive updates until the vehicle is connected to the network.
- If you have any further questions, please contact the XPENG Car Service Center or the Customer Service Center.



System Version



On the central control screen, go to “ → **General**” XOS version number “**interface, and tap the**” at the top to view the details of the current infotainment version.

Update settings

Tap “**Update Settings**” to set the “**Auto Update**” function. When the vehicle detects a new update later, it will automatically update at 3:00 am without manual confirmation.

Tips

It is recommended to enable “” the automatic update feature to keep the vehicle systems up to date at all times.

Update Method

When a new version is available, the system will push a notification to remind you that there are new versions for update. The “**System Update**” bar will display the “**New Version**” icon. The System Update icon will appear on the status bar at the top of the central control screen .

Tap the Update icon on the status bar of the central control screen, or tap the “**System Update**” bar to view the update description of a new version.

When there is a new version for update, you can update the system in the following three ways:

Update Now

On the update instruction page of new version, tap “**Update Now**”. The system will prompt you



that the **“vehicle cannot be used during the update process,”** so make sure that the vehicle is parked in a safe area and reserve enough time.

Tap **“Confirm”** to immediately enter the update preparation. At this stage, you can check the update conditions. After confirmation, the process cannot be suspended.

Scheduled update

On the update instruction page of the new version, tap **“Reserve Update”** to set the time period when you do not need to use the vehicle. Tap **“Confirm”**, and the system will be updated when the vehicle is locked during the set period.

After the reservation is updated, the system update page will display the reservation information. Before the update starts, you can tap **“Cancel Reservation”** at any time and reserve another system update time.

Remote update through mobile app

The vehicle supports remote system updates with **“XPENG App”**. When there is a new

version to update, the App will send a message notification, and the vehicle control interface will display the card of the new version, or the **“New Version”** icon will be displayed on the upper left corner of the vehicle control. Tap the card button or the **“New Version”** icon to enter the remote system update interface, and tap **“Update Now”** to complete the update.

Cautions and Limitations

- Before updating, be sure that the vehicle SoC is greater than 10%, the gearshift lever is in the P position, and the vehicle is parked in a safe area.
- Once the update starts, it cannot be stopped and the vehicle cannot be used during the update. Please leave enough time to wait for the update to complete.
- The vehicle cannot be charged during updating. Please arrange the time for updating and charging reasonably.
- System update failure may cause some functions to be abnormal. If the update fails,



do not use the vehicle. Tap **“Retry”** to retry the update. If retrying for several times fails, please contact the XPENG Service Center or Customer Service Center.

- Once updated, the system cannot be reverted to previous versions.

XPENG App

Introduction

After downloading and logging into the XPENG App on your mobile phone, you can remotely check vehicle status and control certain vehicle functions.



1. Door lock

- When the phone key is not activated, tap **“Activate Key”** to activate the phone key. After successful activation, the original **“Activate Key”** state changes to **“Door Lock”**.
- When Bluetooth is not connected, tap to select **“Unlock Only”** or **“Unlock and Start”**.
- When Bluetooth is connected, tap **“Unlock the vehicle”**, and then engage a gear within 20 minutes to start the vehicle.



i Tips

- Do not close the mobile app after unlocking, leave the mobile app in the background, or you may not be able to engage the gear.
- If you cannot engage gear, try opening the phone app again.

2. Digital key: Tap to enter the digital key interface for Bluetooth key settings and key checks.
3. Bluetooth state: When the phone key is connected to the vehicle Bluetooth, it is blue; when not connected, it is gray.

i Tips

- When the phone key is connected to the vehicle's Bluetooth, it can also be used in a non-networked environment such as a garage.
- The vehicle is equipped with both Bluetooth Media and Bluetooth Key, the phone key automatically connects to

Bluetooth without pairing in the central control screen.

- Bluetooth connectivity is usually about 20 meters in the open field, affected by the mobile phone Bluetooth hardware, the environment, and other factors, there will be differences.

4. Remote start: Tap to unlock the door, press brake pedal within 2 minutes to engage a gear and then the vehicle can be started for others to drive temporarily.
5. Setting: Tap to enter the setting interface.
6. Shortcut bar: Long press this area to customize the functions of the shortcut bar, with a maximum of 8 functions.
7. Vehicle location/map
 - Only the owner account can view the real-time location of the vehicle.
8. Temporary stop: When the **“Power Off Automatically”** function on the central control screen is turned off and the vehicle is in the power-on state, the gearshift lever is at



the P position. Open the mobile APP, go to the “XPENG” interface, and tap “**Temporary Stop**”. In the pop-up prompt window, tap “**Confirm**”. The vehicle will be locked, and the touchscreen and A/C will remain available.

If you have turned on “**Power Off Automatically**” on the central control screen, the vehicle will power off automatically after one hour.

9. Key check: When you bring the phone key close to the vehicle, Bluetooth will be automatically connected. If it has not been connected or the vehicle cannot be started by engaging a gear, you can tap “**Key Check**” for guidance to resolve the issue.
10. Bluetooth key setting: After activating the phone key, you can configure the Auto Unlock or Lock [See 205 page](#).
11. Vehicle authorization: Authorize the vehicle to other XPENG accounts, and a maximum of 5 accounts can be authorized.

caution

Vehicle authorization needs to be networked and there may be instances of delayed feedback, if in doubt try again. In order to unlock and lock the vehicle with a faster response, in the system permissions settings, turn on the following permissions for the XPENG Motors app:

- Non-iOS systems: Bluetooth permission; Self-Launch permission; Background Run permission.
- IOS system: Location information - always allowed; Background app refresh; Location service (Phone settings → Privacy → Location service).



Environment simulation display SR

Introduction

The system uses sensors to detect external road conditions and the current state of the vehicle, and displays real-time information such as other road participants on the dashboard and central control screen, thus creating a virtual display interface centered on the vehicle.

The SR interface includes the following functions:

- Driving Risk Alert Sound [See 81 page](#)
- Preceding Vehicle Starting Reminder [See 82 page](#)
- Green Light Reminder for Starting [See 83 page](#)

Warnings, Cautions and Limitations

warning

SR is an assisted driving function only and you, as the driver of the vehicle, are responsible for driving safety and do not rely on this function

to control the vehicle as injury or death may result.

warning

The SR does not work in the following scenarios:

- Camera restricted
- The vehicle is traveling on a large bend or in poor road conditions.

warning

The SR may have the following conditions:

- An object of one type is displayed incorrectly as an object of another type.
- Shows an object in the wrong direction, distance simulation.

The above warnings, cautions, and limitations do not cover all conditions that may affect the normal operation of SR.



Driving Risk Alert Sound

Introduction

When the driver assistance system is not turned on and the vehicle is in D gear, if the surrounding dynamic obstacles are close to the vehicle or there are potential safety risks, the SR interface will give a warning.

The medium-risk obstacle warning will turn red, and the high-risk one will also turn red with a prompt sound.

Real-time Virtual Reality Assist

Operation



4

On the central control screen, go to “ → **Real-time VR Assist**” interface, and you can turn on or off “**Driving Risk Alert Sound**”.

Warnings, Cautions and Limitations

The Driving Risk Alert Sound feature is only used for warning, and the driver has the responsibility to observe the surrounding environment and make decisions accordingly.



⚠ warning

A trip hazard alert may not be triggered in the following situations. This includes, but is not limited to:

- Radar or camera restricted.
- Driving on a road surface with a large bend.
- When driving on road surfaces in poor conditions and conditions.

The above warnings, cautions, and limitations do not cover all situations that affect the normal operation of the Driving Risk Alert Sound feature.

Preceding Vehicle Starting Reminder

Introduction

When the ADAS is not activated and the vehicle is in D gear, if in a congested road section, and the preceding vehicle moves a certain distance away, the SR interface will display an animation effect and play a prompt sound to remind the driver to start moving.

Operation

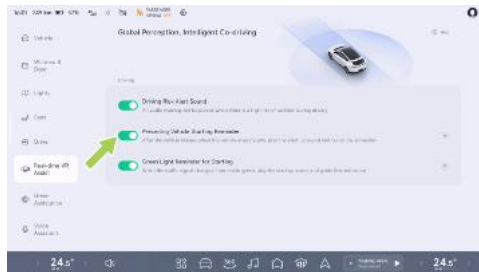

4

On the central control screen, go to “ → **Real-time VR Assist**” interface, and you can turn on or off “**Preceding Vehicle Starting Reminder**”.

Warnings, Cautions and Limitations

⚠ warning

The Front Launch Alert may not be triggered if:

- There are pedestrians, bicycles, motorcycles, etc. in front of you.



Real-time Virtual Reality Assist

- No vehicles ahead.
- The vehicle is in gear other than D.
- The vehicle speed is greater than 0 km/h.
- The vehicle in front is a long distance from the vehicle in front.
- The front and rear vehicle are stationary for a short period of time.

warning

The front drive away alert can be inhibited under certain conditions, including but not limited to the following:

- Poor visibility at night.
- Poor visibility due to bad weather such as heavy rain, heavy snow, fog, sand, etc.
- Intense light, backlighting, water reflective, extreme light contrast.
- Camera restricted

The above warnings, cautions, and limitations do not cover all conditions that affect the normal

operation of the Preceding Vehicle Starting Reminder feature.

Green Light Reminder for Starting

Introduction

When the driver assistance system is not turned on and the vehicle is in D gear, if the traffic light turns green during stopping and waiting, and the current vehicle is not started, the SR interface will display the animated effect of green light starting, and at the same time give a prompt sound to remind the driver to start.



Operation



On the central control screen, go to “ → **Real-time VR Assist**” interface, and you can turn on or off “**Green Light Reminder for Starting**”.

Warnings, Cautions and Limitations

warning

Green Launch Reminder may not be triggered in the following situations, including but not limited to:

- The system does not recognize the traffic light message.
- Vehicles or non-motorized vehicles or pedestrians are in front of you.
- The vehicle is in gear other than D.
- The vehicle speed is greater than 0 km/h.

Green Launch Alerts are inhibited under certain conditions, including but not limited to the following:

- Poor visibility at night.
- Poor visibility due to bad weather such as heavy rain, heavy snow, fog, sand, etc.
- Intense light, backlighting, water reflective, extreme light contrast.
- Camera restricted

The above warnings, cautions, and limitations do not cover all conditions that affect the normal operation of the Green Light Reminder for Starting feature.



360° Panoramic Image AVM

Introduction

The 360° Around View Monitor (AVM) captures the surrounding environment of the vehicle through the surround-view cameras around the vehicle and displays the environment on the central control screen.

The surround-view cameras are installed above the front and rear license plates and beneath the left and right side mirrors [See 26 page](#).

warning

The AVM is an assistance function for reference only and does not replace the driver's view of the surrounding environment. AVM cannot handle all traffic, weather and road conditions, and you, as the driver of the vehicle, are responsible for driving safely, do not rely on this feature to control the vehicle. Failure to do so could result in injury.

Operation

Turn on or off AVM

You can enable the AVM function through any of the following methods:

- AVM automatically activates when the gear is switched to Reverse (R) mode.
- On the bottom taskbar of the central control screen, tap the  icon (if set).
- Use voice commands such as "Turn on the AVM" to activate AVM.
- If the steering wheel shortcut key on the central control screen is set to "**360 Camera on or off**", you can use the steering wheel shortcut key to enable the 360 camera.

You can disable the AVM function through any of the following methods:

- On the 360 Camera interface, tap  in the upper left corner to turn off the 360 camera.
- Use voice commands such as "Turn off the AVM" to disable the AVM.



- If the steering wheel shortcut key on the central control screen is set to “**360 Camera on or off**”, you can use the steering wheel shortcut key to disable the 360 Camera.

2D mode interface



1. Image Settings

Tap “” to jump to the “**Intelligent Imaging**” interface, where you can set image-related functions.

2. Safety stop line

- It indicates the position about 0.3 m behind the vehicle.

warning

Stop the vehicle when the safety stop line contacts an obstacle.

3. Tire track surface

- It indicates the driving route of wheels.

4. Dynamic auxiliary line

- The width of the vehicle is indicated by two thin white lines.
- In the front or rear view, segmented scale lines are used to indicate the distance between vehicles and objects.
- The distances indicated by each scale line from near to far are about 0.6m, 1m and 1.5m respectively.

5. 3D/2D mode switching.

6. View switching icon.



- In 2D mode, you can tap  on the vehicle model to switch between front, rear, left, right, and wheel hub views.
- If no screen interaction occurs within 5s, icons will automatically hide. Tap the top view area to display them again.

7. Distance Monitoring

- It simulates display according to the distance and direction of obstacles.
- When white is displayed, the distance is long.
- When red is displayed, the distance is very close.
- The distance between the vehicle and the nearest obstacle will also be displayed as a numerical value in front of and behind the vehicle respectively.

3D mode interface



- After the system is switched to the 3D mode, it will integrate the 3D virtual model into the real environment image.
- You can swipe the left model ring around  or directly swipe the right model to achieve free 360° rotation.
- If there is no operation on the screen within 5 seconds, the circle and icon will be automatically hidden. Tap the top view area to display the circle and icon again.



Reversing image hold of shifting to R gear

On the central control screen, go to “ → **Driver Assistance** → **Parking**” interface, and you can turn on or off “**Reversing Image Hold**”.

When the function is activated and the gear is shifted from R to D, the AVM will be switched to the front view. When the gear is shifted to P or the vehicle speed exceeds 10 km/h, the AVM will exit automatically.

Automatic 360 camera OFF

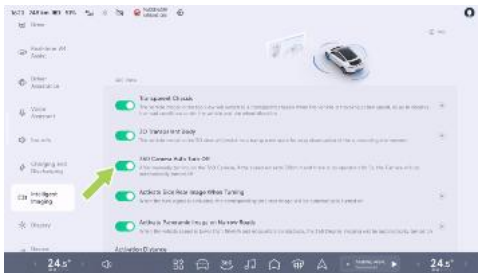

On the central control screen, go to “ → **Intelligent Imaging**” interface, and you can turn on or off “**360 Camera Auto Turn**” Off.

Once the function is enabled, manually turn on the AVM. If there is no operation for 5s when the speed exceeds 30 km/h, the AVM will be automatically turned off.

Warnings, Cautions and Limitations

warning

Objects in the AVM picture are deformed from actual objects.

AVM may not work in the following scenarios:

-
- Camera blocked (dust, cover, etc.) or poor weather conditions (e.g. heavy rain, heavy snow, heavy fog).

The above warnings, cautions, and limitations do not cover all conditions that may affect the normal operation of AVM.



3D Transparent Body

Introduction



When the 3D transparent body feature is enabled and the AVM interface is switched to 3D display mode, the 3D vehicle model on the right will become semi-transparent, aiding in assessing collision risks around the vehicle.

warning

The 3D Clear Body is an aid for reference only and does not replace the driver's view of the

surrounding environment. The 3D transparent body cannot handle all traffic, weather and road conditions, you as the driver of the vehicle are responsible for driving safety, do not rely on this feature to control the vehicle. Failure to do so could result in injury.

Operation

Turn on or off 3D Transparent Body

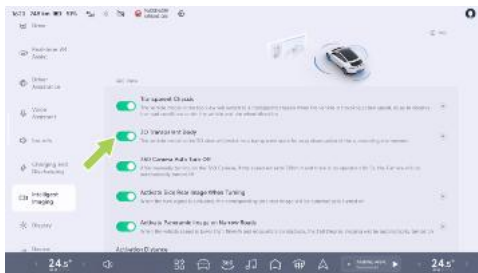

Intelligent Imaging



On the central control screen, go to “ → **Intelligent Imaging**” interface, and you can turn on or off “**3D Transparent Body**”.

Transparent Chassis

Introduction

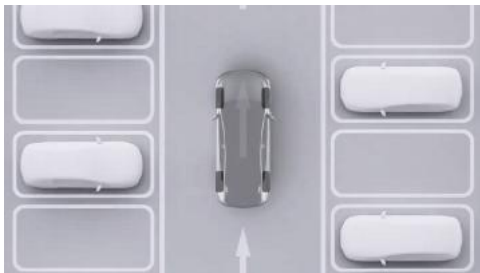

When the transparent chassis feature is enabled and the vehicle is traveling at low speeds, the left side's top view will switch to transparent chassis mode. This displays a virtual vehicle model superimposed on the real-time road conditions,

making it easier to identify any potential collision risks around the vehicle.

warning

The transparent chassis is an aid for information only and does not replace the driver's view of the surrounding environment. The transparent chassis cannot handle all traffic, weather and road conditions, and you, as the driver of the vehicle, are responsible for driving safely, do not rely on this feature to control the vehicle. Failure to do so could result in injury.

5



Operation

Turn on or off transparent chassis

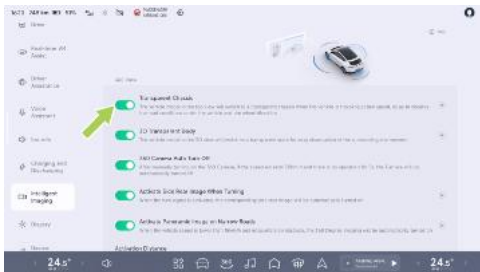

On the central control screen, go to “ → **Intelligent Imaging**” interface, and you can turn on or off **“Transparent Chassis”**.

Activate Panoramic Image on Narrow Roads

Introduction



When the vehicle is in the D gear and the speed is less than 15 km/h, if obstacles are detected on both sides of the front and rear of the vehicle, the vehicle will turn on the Activate Panoramic Image on Narrow Roads for driving assistance.





⚠ warning

Narrowband Active Panorama is an assistance function for reference only and does not replace the driver's view of the surrounding environment. You are responsible for driving safely as the driver of the vehicle, and do not rely on this feature to control the vehicle. Failure to do so could result in injury.

Operation

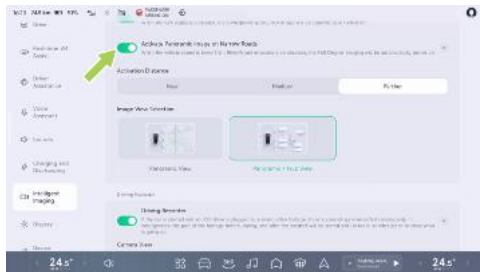
Turn on or off Activate Panoramic Image on Narrow Roads



On the central control screen, go to “ → **Intelligent imaging**” interface, and you can turn on or off “**Activate Panoramic Image on Narrow Roads**” and select activation distance and image view according to your driving habits.

Activation distance: close about 50 cm, medium about 60 cm and far about 75 cm.

The image view can be set to “**Panoramic View**” or “**Panoramic + Hub View**”.



Activate Side Rear Image When Turning

Introduction



When the vehicle is in the D position and the turn signal is turned on, the rear image of the corresponding side will be automatically turned on for the driver to view the rear blind spot on the side and assist in driving.

warning

Rear View on the steering active side is an assistance function for reference only and does not replace the driver's view of the surrounding environment. You are responsible for driving safely as the driver of the vehicle, and do not rely on this feature to control the vehicle. Failure to do so could result in injury.

Operation

Turn on or off Activate Side Rear Image When Turning



Intelligent Imaging



On the central control screen, go to “ → **Intelligent imaging**” interface, and you can turn on or off “**Activate Side Rear Image When Turning.**”

Driving Recorder*

Introduction



The Driving Recorder feature enables video recording during driving and stores the videos on a USB drive. The video files can be used to

review past information or assist with evidence collection in the event of an accident.

Operation

Turn on or off Driving Recorder

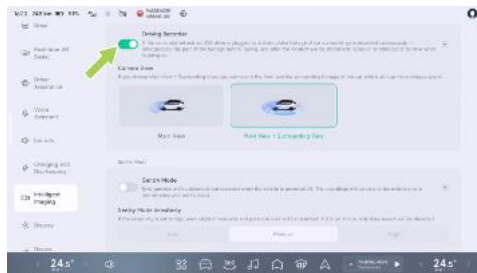

5



On the central control screen, go to “ → **Intelligent imaging**” interface, and you can turn on or off “**Driving Recorder**”.

The Driving Recorder feature supports recording the “**Main View**” or “**Main View + Surrounding View**”.



Emergency Driving Recording

Automatic trigger: On the central control screen, when “**Driving Recorder**” is turned on and the recorder is working, the vehicle will automatically start emergency recording and save the video upon detecting a collision risk.

Manual trigger: On the central control screen, when “**Driving Recorder**” is turned on and the recorder is working, you can tap the  icon on the status bar at the top of the central control screen, and then tap “**Emergency Recording**” in the drop-down menu icon, or tap the  icon (e.g., custom settings) at the bottom taskbar of the central control screen to record a video for emergency.

Emergency video storage location: On the central control screen, go to “ → **Driving Recorder** → **Emergency Recording**”, and you can view and export the emergency videos.

View Driving Recorder status

Tap the  icon on the status bar at the top of the central control screen, and you can view the status of the driving recorder.



When Driving Recorder is turned on and in progress





When Driving Recorder is turned off



When Driving Recorder is unavailable and the USB drive needs to be checked

Export driving videos to a mobile phone

On the central control screen, go to “ → **DVR**” interface, tap “**Select**” to choose the video you want to transfer, tap “” (or the  icon in the lower right corner of the Video interface) to enter the File Transfer interface, and follow the prompts to complete the transfer:



1. Connect the mobile phone to the IVI hotspot;
2. Open the XPENG App and log in to your account;
3. Select the device to which the file is transferred from the central control screen;
4. After a pop-up window is displayed in the mobile app, tap **“Receive”** to transfer the file to the album on the mobile phone.

i Tips

- During file transfer, the central control screen and the mobile app should remain on the transfer interface and keep the mobile phone WiFi turned on to avoid disconnecting.
- During the file transfer, the phone will not be able to access the Internet and will resume after the transfer is complete and disconnected.

Install external storage device

The driving video data will be stored in an external storage device (USB drive). If the USB

drive is not installed, Driving Recorder cannot be used properly.



The USB media source port and Type-C power port located at the front of the central armrest storage box support data transmission function. Once a USB drive is inserted, the Driving Recorder feature can be used.

Only one USB drive is recognized for driving video recording at a time. The vehicle will prioritize the USB drive used before the previous power-off at each time of power-on. If the previously used USB drive is not recognized



within three seconds after powering on, the vehicle will use the first USB drive detected in the reading sequence as the active drive.

Warnings, Cautions and Limitations

- Each video segment is approximately three minutes long by default. If operations such as locking the vehicle, powering off, ejecting the USB drive, clearing videos, formatting, or switching recording views occur during recording, the recording will be interrupted. In such cases, the current video will be saved, and a new video will start recording, which may be shorter than one minute.
- Avoid emergency power-off during recording, as this will prevent the current video from being saved.
- Driving recording videos are stored on a separate U disk. Please do not remove the U disk directly. To pull it out, please first go to the central control screen, “ → **Driving Recorder** → **Storage Management**” interface, and tap “**Safe Eject**”. Otherwise, the video currently being recorded may be lost, and there may be damage to the U disk, or the video data may be corrupted or lost. Please try to avoid the use of adapters or docking stations, as they may cause unstable connections.
- When Driving Recorder is turned on, videos will be recorded in a loop, with the earliest videos overwritten once storage is full. To ensure important videos are not overwritten, please export them to other devices such as mobile phones or computers in time when necessary.
- For better compatibility, please use a USB drive with a capacity of 32GB or higher, USB 2.0 or above, and a write speed of 10MB/s or higher.
- Only USB drives formatted in FAT16, FAT32, or NTFS are supported. For USB drives not in the aforementioned formats, it is recommended to proactively format the drive. Formatting a USB drive will delete all its files, so save important data before formatting.



- USB drives have a limited write/erase lifespan and is considered a consumable product. If you notice slow video reading speeds or frequent video loss after six months of use, replace the USB drive with a new one.
- For your driving safety, exercise caution when viewing video content when the vehicle is running.

Sentry Mode

Introduction



Once activated, the function will continuously monitor the vehicle's surrounding environment after locking and power-off. If continuous approach or abnormal vibration is detected, it will trigger an alarm (the central control screen lights up and the vehicle's lights flash) and record videos before and after any potential risks, effectively documenting potential safety hazards and acts of malicious damage. For vibration events, users will be promptly notified via mobile App push notifications and desensitized high-risk sentinel videos to ensure timely alerts.

You can perform the following actions in sentry mode:

- Turn on or off and set the sentry mode on the central control screen.
- View the sentry videos on the central control screen.
- Turn on or off the sentry mode via the mobile App.



Operation

Turn on or off and set the sentry mode on the central control screen



On the central control screen, go to “ → **Intelligent imaging**” interface, and you can turn on or off “**Sentry Mode**” and configure its sensitivity.

View the sentinel video on the central control screen

On the central control screen, go to “ → **DVR** → **Sentry Mode Recordings**” to view the original Sentry recordings.

caution

Filming may fail if the system runs out of space.

Turn on or off the sentry mode via the mobile App

In the mobile app, go to the “**XPENG**” interface, and you can turn on or off Sentry Mode.

Warnings, Cautions and Limitations

- When using sentry mode, the system will access camera permissions to monitor the surroundings of the vehicle. Please ensure that you comply with local laws and regulations, as well as the camera usage regulations of your location when using sentry mode, and take full responsibility for its use.



- Once sentry mode is activated, the vehicle's anti-theft alarm may simultaneously trigger in response to illegal intrusions, such as attempts to pry open the door or trunk.
- Sentry mode only remains active during a single period away from the vehicle and will be automatically disabled when the vehicle is powered on.
- Sentry mode consumes a certain amount of battery power. Please turn on it only when necessary.
- Sentry mode will continuously consume battery power during its operation. Sentry mode will automatically deactivate when the vehicle's driving range drops below 50 km.



Adaptive Cruise Control (ACC)

Introduction

ACC can control the vehicle to follow other vehicles as per the set distance. If the preceding vehicle stops, the current vehicle can stop following. If the preceding vehicle starts, the current vehicle can start to follow. If there is no target ahead for following, the vehicle will start and run at the set maximum cruise speed.

ACC also has adaptive turning cruise (ATC) function. ATC obtains the curvature of the road ahead through the camera. When ACC is turned on and the vehicle follows the lane line or the preceding vehicle turns, ATC improves the turning comfort and stability by adjusting the speed.

i Tips

- The brake lamp illuminates when ACC actively decelerates away from the vehicle in front, and the accelerator pedal does not move when ACC actively accelerates.

! warning

ACC is only a driving aid and cannot handle all traffic, weather and conditions, and you, as the driver of your vehicle, are responsible for driving safely. Please hold the steering wheel all the way, observe the road, and take over in case of danger. Do not rely on this feature to control the vehicle, as injury or death may result.

Indicators on Dashboard



ACC is not available.



The ACC can be activated when the ACC activation conditions are met.



ACC activated.



Maximum speed limit of ACC/LCC, and any function activated.



Maximum speed limit of ACC/LCC not activated.



System is faulty.

Operation

Activate ACC

When ACC can be activated, the  indicator on the dashboard will illuminate.



Pull the gearshift lever downward to the end once to activate the ACC, and the  icon on the SR interface will illuminate, with a voice prompt.

i Tips

ACC is activated if the following conditions are met:

- The ACC related components are functional and have a clear view.
- Wipers not in HI.
- The brake pedal is not pressed.
- There are no security risks, including but not limited to:
 - Fasten the seat belt correctly.
 - Hold the steering wheel firmly with both hands.
 - All doors are closed.
 - Tyre pressures are normal.
 - ABS, AEB etc. are not active.
 - Drive without fatigue.



Either of the above conditions is not met, ACC cannot be activated.

Set Maximum Cruise Speed

When ACC is activated, the maximum cruise speed can be set through the left scroll button on the steering wheel or the Speed Assistance System (SAS) [See 157 page](#).



If you roll the scroll button slowly, the maximum change rate of cruise speed is 1 km/h or 1 mile/h. If you roll it fast, the maximum change rate is 5 km/h or 5 mile/h.

Alternatively, apply the accelerator pedal. After the vehicle speed increases, pull down and hold the gearshift lever to set the current vehicle speed as a new cruise speed. If you do not pull up and hold the gearshift lever but release the accelerator pedal, the vehicle will decelerate to the previously set speed and continue cruising.

Set Following Distance

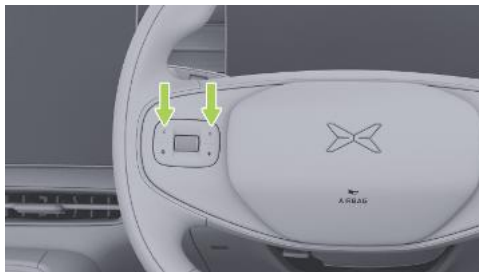

When ACC is activated, you can set the following distance by pressing the left or right button on the left side of the steering wheel. There are 5 gears for selection.



i Tips

When the follow distance is set, the instrument cluster displays the gear position of the gap.

Alarm and take control

! warning

- If the vehicle issues a takeover request via SR interface, voice announcement, etc., take over immediately.
- In the event of a hazard, or in the event of a situation requiring a takeover, take over immediately and do not wait for the vehicle to issue a takeover request.

When ACC is activated, you can take the control by the following methods:

- Apply the accelerator pedal: The vehicle speed is temporarily controlled. After the vehicle speed increases, pull down the gearshift lever to set the current speed as a new cruise speed; or release the accelerator

pedal and the vehicle will decelerate to the previously set speed and continue cruising.

- Press brake pedal: ACC is deactivated and the vehicle decelerates.
- Pull up the gearshift lever: ACC is deactivated, and regeneration will slow down the vehicle.

In addition, when ACC is activated, if the ACC activation conditions change from satisfied to unsatisfied, ACC will exit. Please take control.

Warnings, Cautions and Limitations

Please read all chapters about the ACC in this manual, and you should understand these restrictions before using the function.

ACC is designed for driving comfort and convenience, not as a crash warning or avoidance system. The driver has the responsibility to stay vigilant at all times, ensure driving safety and control the vehicle. Do not rely on the system to reduce the vehicle speed sufficiently to avoid crashes. Be sure to observe the road conditions ahead and be ready to



take corrective measures at any time; otherwise, serious injury or even death may result.

It is your responsibility to determine and always keep a safe following distance. Do not rely solely on ACC to maintain an accurate or suitable following distance.

warning

ACC is a driving aid and cannot handle all traffic, weather and road conditions, do not use or switch ACC on in the following scenarios:

- Road with varying conditions such as twists and turns (s-bends, continuous u-bends, etc.).
- Roads that are in poor condition, such as icy or slippery roads.
- In bad weather conditions, such as heavy rain, heavy snow, heavy fog, etc.
- Urban roads.

warning

ACC does not respond fully in the following special conditions, difficult road conditions, poor weather or light conditions, be sure to be concerned with the environment and conditions. Be alert, always place your hand on the steering wheel and take over the vehicle at any time, including but not limited to:

- Suddenly another vehicle moves quickly or at a close range to the front of the vehicle.
- When adjacent lane vehicles have only part of the body cut into front of the vehicle (especially large vehicles such as buses, trucks, etc.).
- The vehicle ahead slows down suddenly.
- Make a U-turn or drive in through the vehicle.
- When driving in tunnels or at night, when trucks, buses, or vehicles with oversized loads are in the side lane.
- When approaching or cornering through a road, there are multiple vehicles in parallel.



- For stationary vehicles or objects, such as obstacles to the road surface, especially if the vehicle ahead leaves your driving lane causing the vehicle or object ahead to be stationary.
- On an uphill section.
- Increase ground speed when descending a hill, when the vehicle exceeds a set speed or road speed limit.

warning

ACC is unable to fully recognize and respond to the following environments and targets, it is important to keep an eye on the environment and road conditions and take over the vehicle in a timely manner to ensure safe driving in the following scenarios. This includes, but is not limited to:

- The following targets are encountered in front of the drive, including but not limited to:
 - People, animals.

- Traffic lights.
- Walls, roadblocks.
- Two-wheelers (bicycles, motorcycles, electric cars, etc.), three-wheelers.
- Other non-vehicle objects.
- Target in sensor blind area.
- Vehicle or object on the other side of the ramp.
- In the event of a vehicle traveling in opposite directions.
- When the vehicle in front is fitted with an object that protrudes beyond its body.
- In the event of construction, accidents, etc.

The above warnings, cautions, and limitations do not cover all conditions that may affect the normal operation of ACC.



Lane Centering Control (LCC)

Introduction



LCC is a comfortable driver assistance function, which can assist the driver to control the steering wheel and keep the vehicle centered in the current lane to the greatest extent.

When LCC is activated, ACC will be activated synchronously. The longitudinal speed and distance are controlled by ACC. LCC assists the driver in controlling the steering wheel to keep the vehicle centered within the current lane to

the greatest extent on a straight road with clear lane lines on both sides and a standard curvature road.

i Tips

- When LCC is active, the ALC can be used to assist with lane change.
- When LCC is active, the cruise speed and follow distance can be set via the steering wheel keys in the same way as ACC.

! warning

LCC is a driving aid only feature and cannot handle all traffic, weather and road conditions, and you, as the driver of your vehicle, are responsible for driving safely. Please hold the steering wheel all the way, observe the road, and take over in case of danger. Do not rely on this function to control the vehicle, as injury or death may result.



Indicators on Dashboard



LCC is not available.



The LCC can be activated when the LCC activation conditions are met.



LCC activated.



The LCC will exit with a delay.



System is faulty.

Operation

Opening and closing



On the central control screen, go to “→**Driver Assistance**→**Driving**” interface, and you can turn on or off “**Lane Centering Control**”.

Activate LCC

When LCC can be activated, the indicator on the dashboard will illuminate.



Pull the gearshift lever downward to the end twice to activate the LCC, and the  icon on the SR interface will illuminate, with a voice prompt.

Tips

LCC is activated if the following conditions are met:

- The LCC related components are functional and have a clear view.
- Clear lane lines.
- Wipers not in HI.

- The brake pedal is not pressed.
- There are no security risks, including but not limited to:
 - Fasten the seat belt correctly.
 - Hold the steering wheel firmly with both hands.
 - All doors are closed.
 - Tyre pressures are normal.
 - ABS, AEB etc. are not active.
 - Drive without fatigue.

Either of the above conditions is not met, LCC cannot be activated.

Hands-off detection alert

During the use of the function, the system will continuously monitor the driver's grip on the steering wheel in real time. If the driver removes their hands from the steering wheel for a certain period of time, the system will issue a **"Please hold the steering wheel"** prompt accompanied by a voice reminder. At this time, the driver



should re-grip the steering wheel to release the alarm.

If the driver still does not grip the steering wheel, the system will escalate reminders through visual, auditory, and tactile alerts. When continuous hands-off reaches the specified duration, the system will issue a **“Please take over the vehicle immediately”** prompt. At this time, the driver should respond immediately to the vehicle's takeover request and promptly control the direction of the vehicle. During the current driving cycle, if a request for the manual takeover of the vehicle is triggered due to long-period hands-off, the driver assistance function will be disabled for the rest of the trip. To restore functionality, shift to P gear to enable the function.

warning

- The hands-off detection alert is an aid only function and does not replace the driver's judgment on the time to take over, the driver

should stay focused on driving and respond to the system's alert message.

- The driver as the driver of the vehicle has the responsibility to drive safely, in the course of driving should comply with the provisions of traffic regulations, consciously keep the driving all the way with both hands on the steering wheel, do not use any means to deceive the hands-off detection system.

Alarm and take control

warning

- If the vehicle issues a takeover request via SR interface, voice announcement, etc., take over immediately.
- In the event of a hazard, or in the event of a situation requiring a takeover, take over immediately and do not wait for the vehicle to issue a takeover request.

For the method of adjusting cruise speed and following distance by LCC, please refer to the



descriptions in “**Set the Maximum Cruise Speed**” and “**Set the Following Distance**” under ACC.

When LCC is activated, you can take the control by the following methods:

- Turn the steering wheel: to temporarily control the steering wheel. After the vehicle is changed to a new lane, LCC can be automatically reactivated.
- Apply the accelerator pedal: to temporarily control the vehicle speed.
- Press brake pedal: to disable ACC and LCC.
- Pull up the gearshift lever: to disable ACC and LCC.

In the following Combos, LCC will be downgraded to ACC. In such case, please get ready to take control of the vehicle:

- The lane line is not clear.

If the current vehicle status does not meet the ACC activation conditions, LCC will exit directly.

Warnings, Cautions and Limitations

Please read all the contents about LCC in this manual, and you should understand these restrictions before using the function.

LCC is designed for driving comfort and convenience, and cannot cope with sudden dangerous situations. The driver has the responsibility to stay vigilant at all times, ensure driving safety and control the vehicle. Do not rely on the system to deal with emergencies. Be sure to observe the road conditions ahead and be ready to take corrective measures at any time; otherwise, serious injury or even death may result.

warning

The LCC cannot handle all traffic, road conditions and weather, do not use or turn on the LCC in the following scenarios:

- Road with varying conditions, such as twists and turns.
- At the junction or divergence of the road.



- Roads that have been constructed or modified.
- When lane line disappears or disconnects.
- When the lane line is blurred, disappeared, or covered.
- A road with a sharp change in lane direction ahead, such as road divergence, lane merging, sudden lane width increase or decrease.
- Roads that are in poor condition, such as bumps, ice or slippery roads.
- Urban roads.
- At a traffic intersection.
- When the vehicle ahead steers or a vehicle is moving in front of the vehicle.
- A section where pedestrians or cyclists may be present.
- In bad weather, such as rain, snow, fog.
- When the vehicle is in poor condition, for example: Abnormal four wheel alignment, abnormal tire pressures, etc.

warning

The LCC does not respond fully in the following special conditions, complex road sections, weather or poor lighting conditions, be sure to look out for the environment and conditions. Be alert, always place your hand on the steering wheel and take over the vehicle at any time, including but not limited to:

Special road conditions or complex road sections:

- On a sloping road, or on a downhill section.
- High speed turns or sharp turns.
- The intersection has a road/road/zebra line/arrow scene.
- No lane line or excessive wear or blockage, overwriting, or disappearance of lane lines.
- Temporary adjustment or rapid change due to road construction (e.g., lane forking, crossing or merging).



- Special lane change scenarios such as lane diversions, diverting, diverting zones, lane widening, etc.
- There are text or traffic signs on the surface of the road or dense text, traffic signs, asphalt oil, brake marks in the driveway, Tyre marks, ruts, etc.
- Driveway is too wide or narrow.
- The boundary of the road separated by ice cones, water horses, cement mounds, etc.

Complicated road conditions:

- On congested roads.
- Pedestrians or cyclists' roads may appear.
- When other vehicles are moving in front of the vehicle.
- Suddenly a vehicle quickly changes lanes close to the front of the vehicle.
- When the vehicle ahead leaves the lane.
- The vehicle in front is blocking the camera's view or blocking the lane line.

- Large vehicles such as trucks, buses, etc. are on the side or in front.

Poor weather or lighting conditions:

- Objects or landscape features are projected onto the driveway to form large shadows.
- When bright light, such as oncoming headlamp light or direct sunlight, prevents the camera from seeing its sights.
- Windshield glass blocks the camera's field of view (mist, dirt, stickers, etc.).
- When there is a large lateral air flow or high wind on one side of the vehicle.

Radar or camera restricted:

- Radar limited
- Camera restricted
- Radar or camera blocked (dust, cover, etc.) or poor weather conditions (e.g. heavy rain, heavy snow, heavy fog).



⚠ warning

The LCC cannot fully identify and respond to the following environments and targets, it is important to pay attention to the environment and road conditions, take over the vehicle in a timely manner in the following scenarios to ensure safe driving. This includes, but is not limited to:

- Reliance on the system.
- Used when lane lines are not clear or light conditions are poor.
- Used in environments where pedestrians, cyclists or animals are heavy.
- Remove both hands from the steering wheel.
- Line of sight off the road.
- When there are guardrails, barriers or curb stones on one side of the road.
- The LCC will occasionally be able to assist the vehicle when secondary steering is not required or when you do not intend to steer, due to lack of clarity and irregularity in the

lane line or other lines or objects on the surface of the lane that resemble a lane line, and you should take over the vehicle in time.

The above warnings, cautions, and limitations do not cover all conditions that may affect the normal operation of LCC.

Auto Lane Change (ALC)*

Introduction





When LCC is activated and the turn signal is turned on, ALC can assist the driver in changing lanes.

warning

ALC is only a driving aid and cannot handle all traffic, weather and conditions, and you, as the driver of your vehicle, are responsible for driving safely. Please hold the steering wheel all the way, observe the road, and take over in case of danger. Do not rely on this feature to control the vehicle, as injury or death may result.

Operation

Opening and closing



On the central control screen, go to “ → **Driver Assistance** → **Driving**” interface, and you can turn on or off “**Auto Lane Change**”.



Use ALC



1. Check the lane change environment to confirm the safety of lane change.
2. Turn on the turn signal on corresponding side.
3. If the ALC lane change conditions are met, ALC will assist the driver in lane change. If the lane change conditions are not met, a prompt will be displayed on the SR interface.

i Tips

- The ALC can only change lanes one at a time, to change lanes again, switch on the

opposite side of the traffic light/turn signal again.

- ALC cannot change lanes across a solid line.
- Once the ALC is initiated, it will look for the right time for the scene to change lanes, and when it is canceled, The SR screen displays the “**lane change canceled**” as a reminder.
- The traffic/turn signals will switch off automatically when the lane change is completed or canceled using the ALC.

Alarm and take control

! warning

- If the vehicle issues a takeover request via SR interface, voice announcement, etc., take over immediately.
- In the event of a hazard, or in the event of a situation requiring a takeover, take over immediately and do not wait for the vehicle to issue a takeover request.



After ALC is activated, the lane change can be canceled by the following operations:

- Turn the steering wheel: cancel lane change and temporarily control the steering wheel. After conditions are met, LCC will be reactivated.
- Press brake pedal: cancel lane change and exit ACC and LCC.

Warnings, Cautions and Limitations

The ALC is a driver assistance function and cannot realize autonomous driving. When the ALC is activated, the driver still needs to observe the safety of lane change environments to take control of the vehicle in time when there is potential danger.

The ALC is designed for driving comfort and convenience, and cannot cope with sudden dangerous situations. The driver has the responsibility to stay vigilant at all times, ensure driving safety and control the vehicle. Do not rely on the system to deal with sudden emergencies.

Always observe the road ahead and be prepared to take corrective action at any time, as failure to do so could result in serious injury or even death.

The ALC may drop out unexpectedly at any time for unknown reasons. Be sure to observe the road safety situation and be ready to take appropriate measures. The driver is always responsible for safety in the lane change.

warning

Read all of the information about ALC in this manual and you should be aware of these limitations before using the feature.

- The ALC cannot handle all traffic, weather and road conditions and must not operate in bad weather (e.g. rain, snow, fog weather) and where pedestrians or cyclists may be present.
- Do not use the ALC when a vehicle is in front of or adjacent to the side of the vehicle, as it may collide with other vehicles.



- During the use of the ALC, if other vehicles change lane at the same time and the same lane as the vehicle is about to change lane, the function cannot avoid the risk of collision at this time, the driver should always observe the changing lane environment safe and timely intervention in vehicle control. The driver is solely responsible for safely changing lanes to avoid collisions.
- Do not use the ALC when the vehicle is in poor condition, for example: Abnormal four wheel alignment, abnormal tire pressures, etc.
- Do not use the ALC on ramps, commutes, or diverts on highways or other roads.
- Use ALC with caution on cornering, the system may not support lane change assist.
- Do not use the ALC on urban roads or in difficult conditions.
- Do not use the ALC on tight curves, bumps, ice, or slippery surfaces, where the system is unable to stabilize on lane change assist.
- The ALC occasionally recognizes a condition that allows lane change as not allowing lane change, which requires you to change lanes manually.
- ALC may not be able to accurately detect traffic changes on high traffic sections, use ALC with caution.
- Do not use ALC on lanes marked as solid or other road sections with restricted traffic changes.
- When using the ALC, the driver must take over immediately if another vehicle approaches the vehicle quickly, and the ALC cannot avoid a possible collision.
- Do not use the ALC when there are other vehicles in the side rear blind area of this vehicle or in the lane of a traffic change.
- There are sharp turns on the road, or the road is in poor condition, such as rough, slippery or icy roads.
- On a sloping road.
- Pedestrians or cyclists' roads may appear.



- Dark (poor lighting) or poor visibility (due to heavy rain, snow, heavy fog, etc.).
- When bright light, such as oncoming headlamp light or direct sunlight, prevents the camera from seeing its sights.
- The vehicle ahead is blocking the camera's view.
- Windshield glass blocks the camera's field of view (mist, dirt, stickers, etc.).
- Excessive wear or blockage of lane lines, overwriting, overlap of old and new markings, temporary adjustment or rapid change due to road construction (e.g. driveways are split, crossed or merged).
- Objects or landscape features are projected onto the driveway to form large shadows.
- Warning cones, warning signs or other objects are placed on the surface of the road.
- Radar limited

- Radar or camera blocked (dust, cover, etc.) or poor weather conditions (e.g. heavy rain, heavy snow, heavy fog).
- Performance can be compromised when there is large lateral air flow or strong wind on one side of the vehicle, which is not suitable for ALC use.

The above warnings, cautions, and limitations do not cover all conditions that may affect the normal operation of ALC.

Green Light Reminder

Introduction

When driving assist is not enabled and the vehicle is in D gear, if the traffic light turns green but the vehicle is not started while waiting, the SR interface displays a special animation effect for green light start and emit a warning sound to remind the driver to start driving.



Warning, Caution and Limitation

warning

The green light reminder may not be triggered in the following situations, including but not limited to:

- The system did not recognize the traffic light information
- There is a vehicle, non-motorized vehicle, and pedestrian ahead.
- The vehicle is in a non-D gear.
- The vehicle is greater than 0 km/h.

Under specific circumstances, the green light reminder may be restricted, including but not limited to:

- Poor visibility at night.
- Poor visibility caused by adverse weather conditions such as heavy rain, snow, fog, and dusts
- Strong light, backlighting, light reflection by water, extreme light contrast.

- Camera is limited.

The above warning, caution and limitation mentioned above do not cover all situations that may affect the normal operation of the green light reminder.



Front/Rear Distance Monitoring

Introduction

When the vehicle is parked or running at a low speed, the ultrasonic radar can detect the distance between the vehicle and the surrounding obstacles and give a warning through the SR interface and a prompt sound.

caution

- When a red bar is displayed, the obstacle is close to the vehicle and requires extra attention.
- As the distance of the vehicle from the obstacle decreases, the frequency of the warning tone will increase gradually.

Tips

- The radar will only warn you if your vehicle is in D gear at a speed of less than 12 km/h; there is no speed limit for the radar alarm when you are in R gear.

- Radar alerts even if the obstacle is soft (such as tall weeds) and does not damage the vehicle.

Warnings, Cautions and Limitations

warning

Radar alerts may not work correctly in the following scenarios:

-
- The vehicle approaches the obstacle at a faster speed.

The above warnings, cautions, and limitations do not cover all situations that affect the normal operation of radar warning.



Intelligent Parking Assist APA

Introduction



APA can assist the driver in parking in and out of [See 128 page](#) vertical, parallel, and diagonal parking spaces with wired or wireless frames. It supports the following activation methods:

- Central control screen
- Phone key*
- Smart remote control key*

warning

APA is only a driving aid and cannot handle all traffic, weather and conditions, and you, as the driver of your vehicle, are responsible for driving safety. Please hold the steering wheel all the way, observe the road, and take over in case of danger. Do not rely on this feature to control the vehicle, as injury or death may result.

Indicators on Dashboard



The APA can be activated



APA activated



APA unavailable



Operation

Opening and closing

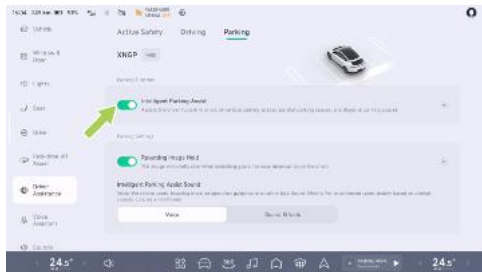

On the central control screen, go to “→**Driver Assistance**→**Parking**” interface, and you can turn on or off APA.

Use APA

1. You can activate the parking mode on the “**Real-time Virtual Reality Assist**” interface by using any of the following methods:

- Automatic switching. When the vehicle enters a parking environment such as an underground parking lot, the “**Real-time Virtual Reality Assist**” will automatically enter the parking mode.
- Tap the steering wheel shortcut key.
- Tap “**Park**” on the central control screen.
- Speak ““**Hey Xpeng, I need to park**””.
- When the SR interface displays the parking space icon, stop and switch to R gear.

2. Drive to find the target parking space.

Tips

- Please keep the lateral distance between the vehicle and the parking space between 1 and 2 meters while finding a parking space.
- When searching for a parking space, the vehicle speed should not exceed 24 km/h.

3. When the target parking space is highlighted, press brake pedal and tap on the central



control screen to select the target parking space.

4. At this time, you can park in the parking space by the following methods:

- Central control screen: Tap “**Start Parking**” on the central control screen, and then release the brake pedal.

i Tips

When the parking card displays the side offset option, confirm the side offset before clicking “**Start Parking**”.

- Remote control key*: Shift to P position, get out of the vehicle and close the doors, press and hold the parking button on the remote control key. Once the side mirrors are folded and the hazard lights are activated, press the parking button on the remote control key twice.
- Phone key*: Shift to P gear, get out of the vehicle and close the doors. Open the intelligent parking module of the mobile

App, and tap “**Remote Parking**”. After the side mirrors are folded and the hazard warning lights are turned on, tap “**Start Park-in**”.

i Tips

- When parking a space using the key fob/handset, the vehicle automatically switches to P, locking the vehicle and de-energizing.
- When parking a space using the key fob/handset key, the smart key/handset needs to be held in the vehicle vicinity or the function will exit.
- When parking a space with the mobile key, the door/boot is allowed to be opened for five minutes after remote parking is suspended, and the door can be closed for access and click Continue to complete remote parking.
- Off-vehicle Parking: On the central control screen, tap “**Off-vehicle Parking**” to pop up a window. After the desirable startup



method is selected, occupants can get off with mobile phones and remote control keys. The vehicle activates the hazard lights and then begins automatic parking.

If **“Start Auto Off-vehicle Parking-in”** is selected, occupants get off with mobile phone and remote control key, then close all doors, and keep a certain distance from the vehicle. The vehicle activates the hazard lights and then begins automatic parking.

If **“Confirm Parking-in Outside Vehicle”** is selected, occupants can get off with mobile phones and remote control key, and close all doors. Parking-in is triggered by any of the following methods:

- Cover the rear side camera at the fender for 3 seconds, the vehicle will activate the hazard lights and then begin automatic parking.

i Tips

This mode is dependent on ambient brightness, if the ambient conditions do not support it. The vehicle broadcast **“cannot be initiated by blocking the camera at this time”**. Please activate the feature with the App.

- The function can be activated by tapping the App notification* or tapping the Charging port open/close & park button on the remote control key*. The vehicle will activate the hazard lights and then begin automatic parking.

i Tips

- Before using Park Away, make sure notification permission is turned on for the mobile app.
- Keep observing the vehicle's surroundings when parking begins, while keeping Bluetooth on and



waiting for the vehicle to be electrically locked before leaving.

Alarm and take control

warning

- If the vehicle sends a takeover request via a meter, voice announcement, etc., take over immediately.
- In the event of a hazard, or in the event of a situation requiring a takeover, take over immediately and do not wait for the vehicle to issue a takeover request.
- Make sure that no one is in the vehicle before parking a space using the Remote Key */Mobile App.
- When using Park Exit, exit the vehicle and close the door, check for children or other important items left behind in the rear seats.

When the APA is activated, it can be paused in the following ways:

- Parking with central control screen: Press brake pedal at any time to suspend the APA.
- Parking with remote control key*: Short press any key on the intelligent key.
- Parking with Phone Key*: Tap the “**Pause**” key on the relevant page in the mobile App.

When safety is confirmed, the APA can be restored by:

- Parking on the central control screen: Tap “**Continue**” on the central control screen.
- Parking with remote control key*: Press the park button on the remote control key twice.
- Parking with Phone Key*: Tap “**Continue**” in the mobile App.

The APA will exit if:

- you turn the steering wheel manually.
- Press brake pedal.
- APA pauses and does not recover after 30 seconds.



- the door is opened, the accelerator pedal or the brake pedal are applied, causing APA to pause 3 times.
- Off-vehicle parking: You can stop parking by opening the door, tapping "End Parking" in the App, pressing any button on the remote control key*, or tapping "Lock" in the App.

Warnings, Cautions and Limitations

warning

Do not use APA in the following scenarios:

- The road is a ramp.
- One or more ultrasonic sensors, the Surround Camera is dirty or obstructed (e.g. sludge, snow or water hanging).
- Poor weather conditions (e.g. heavy rain, heavy snow, heavy fog, etc.).
- The road surface is uneven, icy or slippery.
- Kerb material is not a stone or the curb cannot be detected.

- There are poor surfaces (e.g., cliffs, high platforms, sidewalks facing the street, etc.).
- Fitted with anti-slip chains or spare wheels.
- The loaded object protrudes from the vehicle.
- Either side of the left or right exterior mirrors is damaged or in an incorrect position.
- Parking spaces on narrow streets, or narrow parking spaces.
- Modifications to the vehicle or vehicle repairs carried out at a non-XPENG Automobile Service Center affect the normal functioning of the vehicle.

warning

In the following scenarios, the APA may not be able to take security measures and should take over the vehicle immediately:

- When the instrument or the central control screen sends you a takeover request.
- When APA exits unexpectedly.



- Vehicles, pedestrians and objects were encountered during parking and automatic avoidance or braking was not completed in time.

warning

APA may have the following situations, please note the takeover:

- Obstruction above and above exterior mirror height.
- Dangling, small, and small-width obstructions.
- A target in a camera or radar blind spot.
- Pedestrians or animals.

The above warnings, cautions, and limitations do not cover all conditions that may affect the normal operation of APA.

Auto Exit Parking Assist (AEP)

Introduction

The following methods can be used to pull the vehicle out of a parking space if it has not been moved after parking with the APP [See 122 page](#) Introduction

- Central control screen: Get on the vehicle, close the door, switch to R gear, and tap “**Start Parking-out**” on the central control screen.
- Remote control key: Press and hold the parking button on the remote control key. Once the side mirrors are folded and the hazard lights are activated, press the parking button on the remote control key twice.
- Phone key: Open the mobile App, tap “**Remote Parking**”, and tap “**Start Parking-out**” after the side mirrors are folded and the hazard warning lights are turned on.



i Tips

To access the Park Out feature, log in to the owner's account number on the central control screen and turn on the super smart park switch.

⚠ warning

- AEP is only a driving aid and cannot handle all traffic, weather and conditions, and you, as the driver of your vehicle, are responsible for driving safely. Please hold the steering wheel all the way, observe the road, and take over in case of danger. Do not rely on this feature to control the vehicle, as injury or death may result.
- The APA warnings, alarms and takeovers, etc., also apply to AEP.

Remote Vehicle Summons*

Introduction

You can use the remote control key or phone key to move the vehicle forward or backward, making it convenient for the vehicle to enter and exit narrow parking spaces where people cannot get on or off smoothly.

i Tips

Direct Summon has an obstacle avoidance function, which can be actively suspended if an obstacle is encountered.

⚠ warning

Direct Call is only a driving aid and cannot handle all traffic, weather and road conditions, and you, as the driver of your vehicle, are responsible for driving safely. Do not rely on this feature to control the vehicle, as injury or death may result.



Operation

Opening and closing

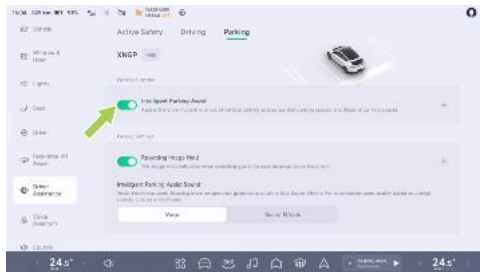

On the central control screen, go to “→**Driver Assistance**→**Parking**” interface, and you can turn on or off APA.

Straight-line calling of remote control key

1. Press and hold the parking button on the remote control key to fold the side mirrors and activate the hazard lights.

2. Press and hold the lock button on the remote control key to move the vehicle forward, or press and hold the unlock button to move the vehicle backward.
3. After entering or exiting the parking space, you can press the lock or unlock button to exit the function.

Straight-line calling of phone key

1. Open the mobile App, tap “**Remote Vehicle Summons**”, and the vehicle's side mirrors fold and hazard warning lights turn on.
2. Tap and hold the switch to control the vehicle to move forward or backward. Release the switch to stop the vehicle.
3. After the vehicle enters or leaves the parking space, tap Back to exit the function.

Alarm and take control

warning

In the event of a hazard or a situation requiring a takeover, the function should be suspended



immediately and never wait for the avoidance to trigger.

Straight-line calling will exit in the following cases:

- The remote key or mobile phone key is too far from the vehicle.
- The Bluetooth between the mobile phone and vehicle is disconnected.
- Obstacle avoidance is triggered 3 times during a single use.
- The vehicle is not controlled to move forward or backward for more than 30s.

Warnings, Cautions and Limitations

warning

Do not use a straight call in the following scenarios:

- One or more ultrasonic sensors, the Surround Camera is dirty or obstructed (e.g. sludge, snow or water hanging).

- Poor weather conditions (e.g. heavy rain, heavy snow, heavy fog, etc.).
- The road surface is uneven, icy or slippery.
- The road is a ramp.

warning

In the following scenarios, a direct call may not be safe and the vehicle should be taken over immediately:

- You are prompted to take over the vehicle.
- Vehicles, pedestrians and objects are encountered during parking and active avoidance or braking is not completed in time.
- Straight Summon unexpectedly exits.

warning

Do not perform the following when using a straight call:

- Line of sight away from vehicle.
- Fully rely on direct calling for parking.

Assisted Parking



The above warnings, cautions, and limitations do not cover all conditions that affect the normal operation of the straight-line calling.

Reversing Assist

Introduction

Tracking reversing is a function that assists the driver to reverse along the original route. After entering difficult road conditions such as dead ends and narrow roads, you can use tracking reversing to get out of trouble.

caution

Followed reversing features an obstacle-avoidance feature, which actively pauses if an obstacle is encountered.

warning

Reverse Trailing is only an aid to driving and cannot handle all traffic, weather and conditions, and you, as the driver of your vehicle, are responsible for driving safely. Do

not rely on this function to control the vehicle, as this may result in an accident.

Operation

Opening and closing

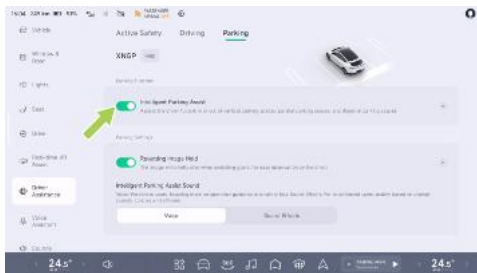

On the central control screen, go to “ → **Driver Assistance** → **Parking**” interface, and you can turn on or off APA.



Use tracking reversing

1. When driving forward at a speed lower than 20 km/h, the system will automatically remember the latest available path.
2. Stop the vehicle and shift to R gear.
3. On the central control screen, tap **“Reversing→Assist Start Reversing Assist”** button.
4. The system will automatically reverse at a low speed according to the effective path.

caution

- A drive path in D below 20km/h is likely to be recorded as a valid path up to 100m.
- Prior to activating follow-through, reversing, turning the steering wheel too far or driving on a hill will clear a valid route.

Warnings, Cautions and Limitations

warning

Do not use follow-through reversing in the following scenarios:

- The road is a ramp.
- One or more ultrasonic sensors, the Surround Camera is dirty or obstructed (e.g. sludge, snow or water hanging).
- Poor weather conditions (e.g. heavy rain, heavy snow, heavy fog, etc.).
- The road surface is uneven, icy or slippery.
- There are poor surfaces (e.g., cliffs, high platforms, sidewalks facing the street, etc.).

warning

Following situations where a trailing reversing maneuver may not be safe, take over the vehicle immediately:

- The system prompts to take over the vehicle.
- When reversing unexpectedly exits.
- Vehicles, pedestrians and objects are encountered during reversing and automatic avoidance or braking is not completed in time.



warning

Take care of the takeover as you may experience the following when using trailing trails:

- Obstruction above and above exterior mirror height.
- Dangling, small, and small-width obstructions.
- A target in a camera or radar blind spot.
- Suddenly approaching a pedestrian or animal.

warning

Do not rely solely on trailing when using trailing trails.

The above warnings, cautions, and limitations do not cover all conditions that affect the normal operation of the tracking reversing.



Forward Collision Warning (FCW&AEB)

Introduction



The forward crash warning includes forward crash warning (FCW) and automatic emergency stop (AEB), which can reduce the risk of vehicle crashes or reduce the speed before vehicle crashes, thus improving driving safety.

warning

Forward Collision Warning does not work when the vehicle is in reverse.

When the system detects a crash risk, it will provide alerts through the SR interface and a prompt sound.

warning

- For pedestrians, two-wheelers, FCW operates at speeds of approximately 10 to 85 km/h.
- For vehicles, the FCW operates at speeds of approximately 10 to 150 km/h.
- When the vehicle gives a warning, the driver should take immediate action and do not wait for the AEB to intervene.

If the risk further increases, and the driver still does not brake or the braking force is too small, the vehicle will brake actively to reduce crashes and injury.



warning

- For pedestrians, two-wheeled vehicles, AEB operates at speeds of approximately 8 to 85 km/h.
- For moving, stationary or slow moving vehicles, the AEB operates between approximately 4 and 150 km/h of the vehicle.
- If the AEB brakes the vehicle, the vehicle will remain stationary for a short period of time and the driver should take the controlled action as soon as possible.
- The driver's application of the accelerator pedal during AEB intervention in the vehicle braking may result in an interruption of braking.

warning

- Forward Collision Warning is an aid that does not work in all driving, traffic, weather and road conditions. There is no substitute for focused driving and accurate judgment,

and the driver is fully responsible for driving safety. Always observe the road conditions while driving and do not rely on forward collision warnings to warn or avoid possible collisions. A number of factors can degrade or affect performance, resulting in unnecessary, inaccurate or ineffective warnings, brake interventions or missed warnings. Reliance on Forward Collision Warning to warn of potential collisions and avoid possible serious injury or death.

- Autonomous Emergency Braking is not designed to prevent collisions. It can only minimize the impact of a frontal impact by attempting to reduce the road speed at most. Relying on Autonomous Emergency Braking to avoid collisions can cause serious injury or death.

Indicators on Dashboard



Forward Collision Warning OFF



Forward Collision Warning fault

Operation

Opening and closing

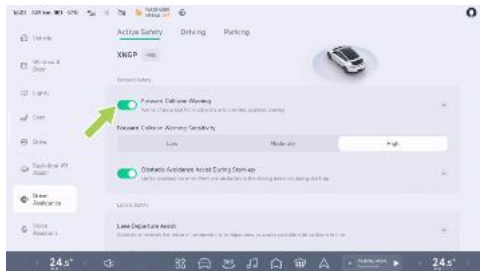

On the central control screen, go to “**Driver Assistance**→**Active Safety**” interface, and you can turn on or off “**Forward Collision Warning**”. After this function is enabled, you can set the forward crash warning sensitivity.

i Tips

Forward collision warning is automatically switched on every time you drive, and it is recommended that it is always switched on for your safety.

Warnings, Cautions and Limitations

Before using FCW, the driver should refer to this chapter for guidance and restrictions on use of relevant functions.

! warning

Do not rely solely on the forward collision warning feature in the following scenarios, which may be limited or inoperable:

- Radar or camera restricted.
- Dark or poor visibility. For example, poor lighting conditions, heavy rain, heavy snow, heavy fog, etc.
- When strong light is obstructing the camera's view. For example, oncoming headlamp light or direct sunlight.



- Windshield glass blocks the camera's field of view (mist, dirt, stickers, etc.).
- Reversing vehicles ahead.
- The vehicle is driven on large bends or in poor road conditions.
- The target appears suddenly. For example, there is a sudden rapid movement of another vehicle or a close movement to the front of the vehicle.
- Insufficient target overlap (coincidence of front and rear width of front).
- Driver brakes, deep accelerator pedal, fast or large steering wheel operation.
- There is a stationary vehicle at the exit and exit of the bend.
- Driving around a bend, the approaching vehicle slows down suddenly.
- A vehicle overtaking from the front at a corner.
- Passing a stationary roadside target or overtaking when changing lanes.

- Front vehicles change lane after braking.
- The vehicle passes through a speed strip, a ground leak, or an iron gate in the garage.
- When the vehicle passes over viaducts, footbridges, under signs.
- When the vehicle passes through viaduct joints, metal barriers at the roadside, etc.
- Traffic lights ahead, water from a sprinkler, splashing water, iron posts on the road, Steel tubes in the sky, floating plastic bags, rolling cans on the road, underground parking, Highway tolls, manholes, etc.

The above warnings, cautions, and limitations do not cover all conditions that may affect the normal operation of FCW&AEB.



Blind Spot Detection (BSD)

Introduction



The blind spot safety assist includes blind spot detection (BSD) and lane change alert (LCA), which can monitor the lanes on both sides of the vehicle and give a warning when there is a risk of lane change.



When the vehicle is in D gear and current vehicle speed is greater than 10 km/h, if there is a vehicle in the blind spot or a quickly approaching vehicle behind the blind spot, the warning light on the corresponding side mirror will be normally on. At this time, if the turn signals on corresponding side are turned on, the warning light on the side mirror will flash to give a warning.

warning

Blind Spot Safety Assist is a driving aid and cannot deal with all traffic, weather and



conditions, and is not a substitute for driver focus and accurate judgment. It is also not intended to replace the use of interior and exterior mirrors. You, as the driver of the vehicle, are responsible for driving safely and it is always the driver's responsibility to change lanes safely. Do not rely on this feature to control the vehicle, as injury or death may result.

Operation

Opening and closing

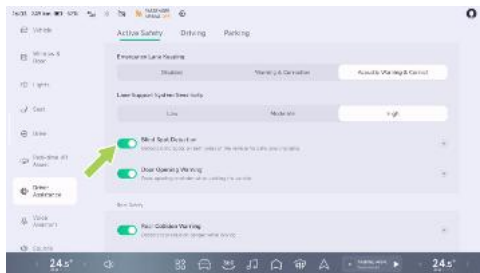

On the central control screen, go to “ → **Driver Assistance** → **Active Safety**” interface, and you can turn on or off “**Blind Spot Detection**”.

Warnings, Cautions and Limitations

warning

The blind area safety assist may not work in the following scenarios:

- Radar limited
- Sharp bends.
- When reversing.
- Large moving metal objects are present in the blind area.

The above warnings, cautions, and limitations do not cover all conditions that may affect the normal operation of the Blind Spot Detection feature.



Door Opening Warning (DOW)

Introduction



When there is a risk of crashes when the door is opened, DOW can remind the driver and passengers.

When the vehicle's speed is between 0 and 5 km/h and vehicles, pedestrians, or two-wheeled vehicles are approaching within the detection range, the DOW triggers a level I warning, indicated by the steady illumination of the warning light on the corresponding side mirror.



If the driver or passenger continues to open the door on the corresponding side, a Level II alarm is triggered, accompanied by the SR interface, a warning sound, and flashing of the door's ambient lights as a reminder.



warning

The DOW is a driving aid only feature designed to alert occupants to the safety of the door when opening a door and to the inability to handle all traffic, weather and road conditions. It is not intended to replace the visual observation of the driver and passengers, and the function of the interior and exterior mirrors. You, as the driver of the vehicle, are responsible for driving safety and do not rely on this feature to control the vehicle, as injury or death may result.

Operation

Opening and closing

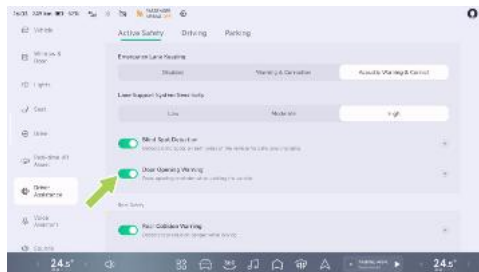

On the central control screen, go to Driver AssistanceActive Safety interface, and you can turn on or off **“Door Opening Warning”**.

Warnings, Cautions and Limitations

warning

DOW may not work in the following scenarios:

- Radar limited



- Smaller targets or stationary targets.
- Target speed too fast or steering behavior. For example: The target vehicle changes lanes directly behind the host vehicle, and other vehicles suddenly change lanes directly behind the host vehicle and are now in the monitoring area.
- Other vehicles, cyclists that appear directly behind the vehicle.
- The vehicle is parked at a corner or near a wall.

The above warnings, cautions, and limitations do not cover all conditions that may affect the normal operation of DOW.

Rear Collision Warning (RCW)

Introduction



During driving, RCW can detect and warn the crash risk behind the vehicle.

When the current vehicle speed is 15~160 km/h, there are vehicles, pedestrians, and bicycles approaching at a certain speed within the detection range and there is a risk of crashes, RCW will give a warning through the SR interface and a prompt sound, and remind you of the



vehicles behind by turning on the hazard warning light.

warning

The RCW is a driving aid and cannot handle all traffic, weather and road conditions, and is not a substitute for driver focus and accurate judgment. It is also not intended to replace the use of interior and exterior mirrors. You, as the driver of the vehicle, are responsible for driving safety and do not rely on this feature to control the vehicle, as injury or death may result.

Operation

Opening and closing

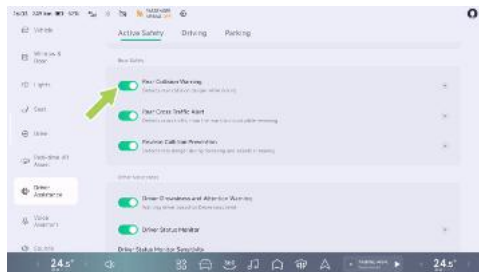

On the central control screen, go to “ → **Driver Assistance** → **Active Safety**” interface, and you can turn on or off “**Rear Collision Warning**”.

Warnings, Cautions and Limitations

warning

In the following scenarios, the RCW may not function properly:



- Radar limited
- Object detection speed is too fast.
- Large moving metal objects are present in the blind area.
- Sharp bends.

The above warnings, cautions, and limitations do not cover all conditions that may affect the normal operation of RCW.

Reverse Collision Prevention RAEB

Introduction



The reverse collision prevention system detects collision risks behind the vehicle while reversing and provides alerts, along with braking assistance.

When the vehicle is in reverse (R) and traveling at speeds from 0 to 18 km/h, and pedestrians approaching at a certain speed within detection range pose a collision risk, the RAEB will notify through the SR interface and a prompt sound.



If the risk continues to escalate and the driver fails to brake or applies insufficient braking force, the RAEB system will activate braking assistance to mitigate or avoid collision-related injuries.

warning

The RAEB function is a driving aid and may not function in all situations, nor is it a substitute for the driver's attention, who is required to reverse safely. Do not use the system when sight is obstructed and traffic conditions are difficult to observe, such as on a busy road or crossing multiple lanes, as the system may not accurately identify cyclists and pedestrians. So you must always be aware of your surroundings.

caution

Once the RAEB brake is parked, the brakes will be maintained for a period of time and the driver should take over the vehicle as soon as possible.

Operation

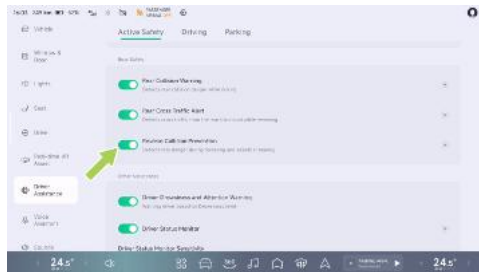

On the central control screen, go to “ → **Driver Assistance** → **Active Safety**” interface, and you can turn on or off “**Reverse Collision Prevention**”.

Warnings, Cautions and Limitations

warning

RAEB may not function properly in all cases and may cause unnecessary, untimely or



ineffective warnings for a variety of reasons. Or omit warnings, such as:

- Radar limited
- Large moving metal objects in blind spot area.
- The object to be detected moves too fast.

The above warnings, cautions, and limitations do not cover all conditions that may affect the normal operation of RAEB.

Rear Cross Traffic Alert (RCTA)

Introduction



When the reversing vision is limited, RCTA can remind the driver of the approaching vehicles in the blind spots on both sides behind.

When the vehicle is in R or N gear, moving at a reverse speed of 2~15 km/h, and a vehicle, pedestrian, or two-wheeler is detected approaching at a certain speed within the detection range posing a crash risk, RCTA is

Active safety



activated, and alerts will be provided via the SR interface and a prompt sound.

warning

RCTA is only a driving aid and cannot deal with all traffic, weather and road conditions, and is not a substitute for driver focus and accurate judgment. It is also not intended to replace the use of interior and exterior mirrors. Do not risk driving because the system improves comfort, reversing safely is always the driver's responsibility and do not rely on this feature to control the vehicle as injury or death may result.

Operation

Opening and closing

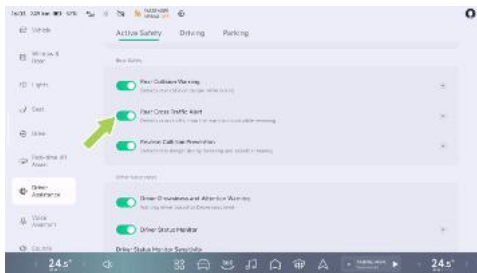

On the central control screen, go to “→**Driver Assistance**→**Active Safety**” interface, and you can turn on or off “**Rear Cross Traffic Alert.**”

Warnings, Cautions and Limitations

warning

Do not use RCTA in the following scenarios:

- Limited field of view.



- Traffic conditions are complex, such as high traffic roads, crossing multiple carriageways.

warning

RCTA may not work in the following scenarios:

- Radar limited
- Object detection speed is too fast.
- Large moving metal objects are present in the blind area.

warning

RCTA may have the following conditions:

- Travellers and two-wheelers are not accurately identified.

The above warnings, cautions, and limitations do not cover all conditions that may affect the normal operation of RCTA.

Startup Safety Assist

Introduction



Start Obstacle Avoidance: When the vehicle starts, if an obstacle is detected in the driving direction and the driver presses the accelerator pedal too fast, the dynamic response of the vehicle will be limited to avoid a crash with the obstacle due to too fast acceleration of the electric vehicle.





warning

Drive Away Avoidance Assist is only a driving aid feature and is not a substitute for direct visual observation, do not rely too heavily on Drive Away Assist. When the feature is activated, vehicle acceleration is limited only to a certain extent and you still need to actively control the vehicle to stop, otherwise a collision will still occur. It is your responsibility to be vigilant, be aware of the vehicle starting environment and always be aware of other road users who could cause serious injury or death.

Operation

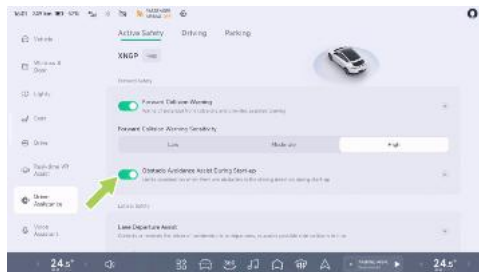
Opening and closing



On the central control screen, go to “→**Driver Assistance**→**Active Safety**” interface, and you can turn on or off “**Obstacle Avoidance Assist During Start-up**”.



Warnings, Cautions and Limitations

warning

Drive-away Avoidance Assist does not always work in a variety of situations, and may cause unnecessary, inaccurate, or ineffective warnings or omissions for a variety of reasons, such as:

- Radar limited
- Large moving metal objects are present in the blind area.
- Object detection speed is too fast.

The above warnings, cautions, and limitations do not cover all conditions that may affect the normal operation of start obstacle avoidance assist.

Lane Departure Assist LSS

Introduction



The LSS includes lane departure warning (LDW), lane keeping assist (LKA) and emergency lane keeping assist (ELK), which can warn and correct unconscious lane departure or possible lateral crash in case of emergency avoidance.

warning

The LSS is a driving aid and cannot deal with all traffic, weather and road conditions, and



cannot replace the driver's dedicated driving and accurate judgment. You, as the driver of the vehicle, are responsible for driving safety and do not rely on this feature to control the vehicle, as injury or death may result.

If the early warning mode is selected, only LDW will be turned on; if the correction mode is selected, all LDW, LKA and ELK will be turned on:

- LDW: When the current vehicle speed is 60~150 km/h and the vehicle deviates from the lane without the corresponding turn signals on, the function will give a warning through the SR interface, a prompt sound, and steering wheel vibration until the driver corrects the vehicle position.

warning

The LDW only alerts and does not correct the vehicle back into the lane, correct the vehicle position in time for the LDW alarm.

- LKA: When the current vehicle speed is 60~150 km/h and the vehicle deviates from

the lane without the corresponding turn signals on, the LKA will give a warning through the SR interface and a prompt sound, and intervene in steering wheel control to correct the vehicle back into the lane.

- ELK: When the current vehicle speed is 60~150 km/h and the vehicle is about to crash with the curb, oncoming vehicles or overtaking vehicles, the ELK will give a warning through the SR interface and a prompt sound, and intervene in steering wheel control for emergency avoidance.

caution

- When the turn signals are on or the driver has a clear intention to turn (e.g. turning the steering wheel quickly, braking, accelerating with a deep accelerator pedal, turning the hazard warning lights on, etc.), Lane Departure Assist will not alert or intervene in lane departure.
- Both the wipers and the dual flashing lamps inhibit the activation of the function.



Operation

Set LSS

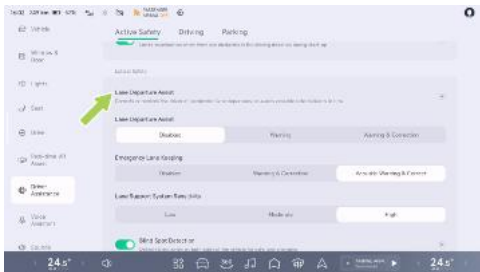

On the central control screen, go to “→**Driver Assistance**→**Active Safety**” interface, and you can set the assistance mode and triggering conditions of the Lane Departure Assist (LDA).

If Lane Departure Assist is set to Warning, only LDW will be turned on; if it is set to Warning & Correct, LKA will be turned on.

Tips

If the ELK function is deactivated, it will be activated again the next time the vehicle is powered on

Warnings, Cautions and Limitations

warning

LSS may not work in the following scenarios:

Special road conditions or complex road sections:

- Excessive wear on lane lines, overlapping old and new markings, temporary adjustments or rapid changes due to road construction (e.g., lane bifurcation, traverse or merge).

Poor weather or lighting conditions:

- When there is a large lateral air flow or high wind on one side of the vehicle.
- Dark (poor lighting) or poor visibility (due to heavy rain, snow, heavy fog, etc.).



- When bright light, such as oncoming headlamp light or direct sunlight, prevents the camera from seeing its sights.
- Objects or landscape features are projected onto the driveway to form large shadows.
- Lane line could not be recognized or incorrectly identified due to light causes, such as strong light causing lane line reflections, bad weather, poor visibility at night or lack of light, etc.

Camera restricted

- Camera restricted
- When the camera is blocked (dust, cover, etc.).
- When there is a vehicle ahead that may obstruct the camera's view.

warning

LSS may have the following conditions:

- Pre-warning or braking without risk of collision.

The above warnings, cautions, and limitations do not cover all conditions that may affect the normal operation of LSS.

Traffic Sign Recognition TSR

Introduction



TSR can identify speed limit signs on the road and obtain speed limit information based on navigation, which is displayed on the displayed on the SR interface. TSR will also give a warning when the vehicle overspeeds.



Speed limit reminder

TSR can identify the speed limit from road signs and intelligent traffic violation monitoring systems, and give a reminder of different icons:



Speed limit on the speed limit sign



Speed limit of the electronic eye



Exceed the speed limit on the speed limit sign



No speed limit sign

i Tips

The signs that the TSR can identify include: Speed Limit ID, Variable Speed Limit ID, Speed Limit De-ID, Zone Speed Limit ID, Multi-lane

speed limit sign, multi-speed limit sign, high-speed exit ramp speed limit sign.

Overspeed alarm

When TSR identifies a road speed limit:

- During manual driving or ACC/LCC-assisted driving, if the road speed limit is exceeded, the speed limit icon on the dashboard will flash and trigger a prompt sound alert.

! warning

TSR is only a driving aid and cannot handle all traffic, weather and conditions, and you, as the driver of your vehicle, are responsible for driving safely. Do not rely on this feature to control the vehicle, as injury or death may result.



Operation

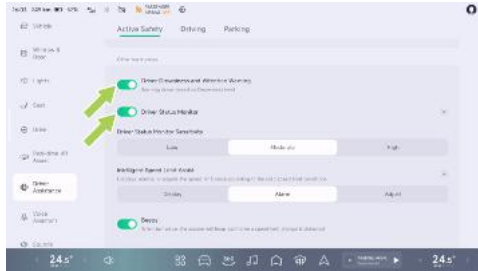

1. Select Intelligent Speed Limit Assist→Display. Only the icon flashes for alarm.
2. Select Intelligent Speed Limit Assist→Alarm→Beeps. The alarm sound will be given every time the speed limit changes.
3. Select Intelligent Speed Limit Assist→Alarm→Alarm Sound. The alarm sound will be given every time the speed limit exceeds.

Warnings, Cautions and Limitations

warning

In the following scenarios, TSR may not work:

- Radar or camera restricted.
- When road or speed limit signs have recently changed.
- When traffic signs are in poor condition.

The above warnings, cautions, and limitations do not cover all conditions that may affect the normal operation of TSR.



Speed Assistance System (SAS)

Introduction



The SAS can set the maximum cruise speed synchronously with the road speed limit identified by TSR.

⚠ warning

SAS is only a driving aid and cannot handle all traffic, weather and road conditions, and you, as the driver of your vehicle, are responsible for driving safety. Do not rely on this feature

to control the vehicle, as injury or death may result.

Operation

Opening and closing

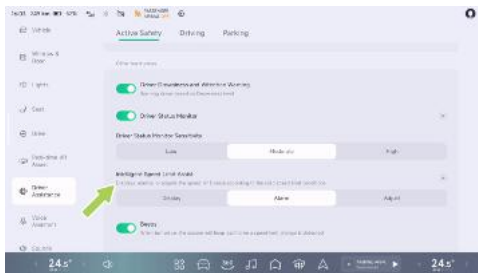

On the central control screen, go to “ → **Driver Assistance** → **Active Safety**” interface, and you can set the SAS assistance mode.

- When you select Adjust for Speed Limit Assist and turn on Confirm Before Speed Adjustment and if ACC/LCC is activated, the speed limit



can only be executed after the driver confirms each change in speed limit.

- When you select Adjust for Speed Limit Assist and turn off Confirm Before Speed Adjustment and if ACC/LCC is activated, the speed limit can be automatically executed without driver's confirmation for each speed limit change.

Warnings, Cautions and Limitations

warning

SAS may not be fully functional or may provide inaccurate information under the following conditions:

-
- Recent changes in roads or speed limits, such as construction, regulations, etc.
- Poor traffic signs: Broken, faded, fuzzy or not placed as required, set.

The above warnings, cautions, and limitations do not cover all conditions that may affect the normal operation of SAS.

Driver Status Monitoring (DSM)*

Introduction



When the vehicle is running, the DSM will monitor the driver's state. Once the driver shows distraction or fatigue, the system will give a warning.

When the driver experiences fatigue or distraction, the system will provide reminders through instrument panel text and sound. While the driver is fatigued or distracted, the system



will increase the sensitivity of LDW and FCW to provide the driver more reaction time.

Operation

Opening and closing

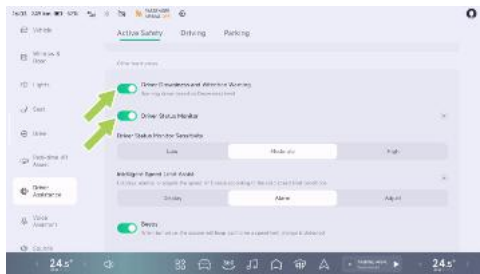

On the central control screen, go to “→**Driver Assistance**→**Active Safety**” interface, and you can turn on or off DSM. The DSM provides high, medium and low sensitivity, defaulting to medium at the time of delivery. Users can adjust it according to their driving preferences.

The system will remember the user's sensitivity selection.

Tips

The DDW switch can only be switched off during each drive, after the alarm has been triggered.

Driver Drowsiness Warning (DDW)

The DDW is used to monitor the driver drowsiness. When the driver is under drowsiness condition, the system will give an alarm to remind the driver to concentrate or take other actions to relieve drowsiness and avoid drowsiness driving.

caution

When DSM/DDW is in operation, the interior camera does not store or transmit personal privacy data such as audio and video.

warning

- When the DSM/DDW is switched off, the driver will not be able to be monitored



for fatigue or distraction and warned that driving safety is compromised, please switch off carefully.

- DSM/DDW is an auxiliary function and must not rely on fatigue distraction reminders to deal with all scenarios, the driver must always maintain a view of the vehicle's control and road environment.
- Keep your eyes on the road and never drive tired. When the system prompts "Keep an eye on the road", ask the driver to adjust their driving behavior promptly or to find a service or safe place to stop and rest as soon as possible.

warning

DSM/DDW does not work in all scenarios, and several factors can cause functionality to fail, such as:

- High or low supply voltage;
- Hardware line disconnect;
- Interior camera blocked or faulty.

The above warnings, cautions, and limitations do not cover all conditions that could interfere with the driver fatigue warning system, and various factors may prevent it from functioning as expected. Please stay alert and always monitor road conditions.



What to Do After a Traffic Accident

Safety Guidelines for Using Driver Assistance Systems

Limitations of Radar and Camera

i Tips

Make sure the radar and camera surfaces are clean and clear before using the Driving Aids feature each time.

⚠ warning

The following conditions can cause the radar/camera to fail to recognize the target, delay in recognition, or incorrect identification:

- The radar or camera is obscured or dirty, such as by snow, frost, rain, Foreign objects such as water, dirt, etc. are attached.
- Faulty radar, camera or associated component.
- Severe weather, such as rain, snow, fog, etc.

- Road bumps or other causes cause the vehicle to rock.
- There is interference from the same frequency of acoustic Boeing sources around the vehicle.
- Objects in the vehicle's vicinity that can cause the sonic to reflect incorrectly.
- The target detected by the radar is attached to substances that absorb sound waves, such as snowflakes, foams, cotton objects, etc.
- The detected object is too small.
- In rare exceptional cases, false alarms may occur on some metal barriers, green belts, cement walls, etc.
- When the ambient brightness changes, such as tunnel entry or exit.
- Large shadows cast by buildings, landscapes or large vehicles.
- The vehicle has crashed and the radar or camera mounting position has been changed.



- High light, such as oncoming headlights or direct sunlight.
- Dark surroundings such as night, dawn, dusk, Tunnels, etc.

warning

The following target radar/cameras are not recognized:

- Special vehicles, such as vehicles with a covered rear, damaged vehicles, or vehicles of irregular shape.
- When you encounter animals, traffic lights, walls and other unknown obstacles in your route.
- Some metal barriers, green belts, cement walls, etc.
- Road test facilities, cone drums, crash buckets, tripods, Small construction plates, etc.
- Static obstacles, such as traffic cones, buckets, traffic columns, warning triangle or other roadblock).

- Static objects, such as slow or stationary sweeper, rolling accident truck, large stones, Tripods, separation belts, pedestrians crossing the road, etc.

Event Data Recorder (EDR)

Introduction

The vehicle is equipped with an event data recorder (EDR).

The EDR can automatically record the vehicle operation and vehicle safety system status information within a period of time before and after the occurrence of vehicle events, such as:

- Vehicle speed.
- Brake pedal status.
- VIN.
- Longitudinal acceleration.
- Driver's seat belt status.
- Accelerator pedal position, percentage of fully open position.



- Power-up period during the event.
- Power-up period when reading.
- Completeness of event data record.
- Time interval between this event and the previous event.
- ECU hardware number for recording EDR data.
- ECU serial number for recording EDR data.
- ECU software number for recording EDR data.
- Lateral acceleration.
- Yaw rate.
- Steering angle.
- The time when the event occurred.
- Gear.
- Brake pedal position.
- Parking system status.
- Airbag deployment time.
- Seat belt pretensioner deployment time.
- Front passenger's seat belt status.
- Occupant protection system alarm status.
- Alarm status of tire pressure monitoring system.
- Brake system alarm status.
- Cruise control system status.
- Anti-lock braking status.
- AEB system status.
- ESC system status.
- Traction control system status.
- Pre-event synchronous timing period.

By collecting and analyzing the vehicle state data recorded by the EDR, it is helpful to understand the relevant situation before and after the event.

The data recorded by the EDR needs to be extracted by connecting special diagnostic equipment to the vehicle OBD port. If necessary, please contact the XPENG Service Center to obtain the equipment.

Declaration of data use

XPENG may use the data recorded by the EDR for fault diagnosis, product R&D and quality



improvement. XPENG will not disclose the data recorded by the EDR to a third party, provided that:

- it is agreed by the owner.
- it is necessary to comply with the requirements of administrative and judicial authorities.
- it is necessary to observe laws and regulations.

Seat belt

Importance of Wearing Seat Belts

Seat belts can be used to restrain the driver and passengers at specified positions to prevent a crash.

In the event of a crash, correctly wearing seat belts can assist other safety systems in absorbing the energy generated by the crash, reduce the inertia of forward motion of the driver and passengers, enable them to get the best protection from the SRS, and minimize injury caused by impact.

warning

In the event of an accident, relying solely on an airbag is dangerous. Without the protection of the seat belt, directly hitting the explosive air bag, the immediate forward movement of the body and the rapid expansion of the air bag will cause more serious damage to the head and chest!

warning

The occupants must wear the seat belts correctly, otherwise the occupants will not only harm themselves but also endanger other occupants in the vehicle when an accident occurs.

warning

It is the driver's responsibility to ensure that all occupants are correctly buckled, turning off the rear seat belt unbuckled reminder carefully when prompted by the central control screen.



Correct Wearing of Seat Belt

Correct driving posture

Whether the driver's sitting posture is correct directly affects the fatigue degree and driving safety of the driver.

To reduce the risk of casualties in accidents, drivers should do the following:

1. Sit upright with both feet on the floor.
2. Make sure your feet can easily step on the pedals. Slightly bend your arms when holding the steering wheel, and keep your chest at least 25 cm away from the center of the steering wheel.
3. The middle section of the seat belt should be placed between the neck and shoulders, and the lap section of the seat belt should be tightly around the hip joint (not the abdomen).

Seat belt pretensioner

In case of a severe frontal crash or side crash, the pretensioner will operate simultaneously

with the airbag. The pretensioner automatically tightens the seat belt, reducing slack in the leg and diagonal parts of the seat belt, thereby reducing the driver's forward tilt.



If the pretensioner and airbag are not activated during a crash, it does not mean that they have a fault. It usually means that the intensity or type of crash is insufficient to activate them.

warning

After an accident, the airbags and other related components must be inspected and



replaced if necessary. Once activated, the seatbelt pretensioner must be replaced.

Check the seat belt

Each seat belt must be subject to the following four simple inspections in order to confirm that it is operating properly:

1. Check if the seat belt, buckle and other devices are damaged, modified, bleached, stained or seriously dirty.
2. Fasten the seat belt and quickly pull out the seat belt in a position closest to the buckle. At this moment the buckle shall be locked securely.
3. Unfasten the seat belt and retract the seat belt to the maximum extent. Check if the seat belt pulled out is of excessive slackness and check for its worn condition.
4. Partially pull out the seat belt, hold the locking tongue and pull it forward quickly. Then seat belts will be locked automatically

by the internal locking mechanism to prevent over-unwinding of seat belts.

If any seat belt fails to pass any of the above tests, immediately contact the XPENG Service Center.

Adjust the front seat belt's height



1. Pinch the guide in the arrow direction and move it up and down to adjust the shoulder belt to an appropriate height.
2. Release the shoulder belt guide.



3. Pull the seat belt sharply to verify whether the guide is securely locked.

warning

Do not adjust the seat belt height while the vehicle is in motion.

Buckling up the seat belt



1. Pull out seat belts slowly, make the seat belts evenly go around the entire pelvis, chest and collarbone to keep them between neck and shoulder.

2. Insert the seat belt locking tongue into the seat belt buckles until it “**clicks**” to ensure that the locking tongue is locked in place.
3. Pull out seat belts hard to check if they are fastened.
4. Tighten seat belts toward the spool to tighten any unexpected slack part.

Unbuckle the seat belt



1. Hold the seat belt locking tongue.
2. Press the unlock button on the seat belt buckle.



3. Continue to hold the seat belt locking tongue and make sure that the seat belt is retracted slowly.

Use of seat belt by expectant mother

Injuries to the expectant mother and her fetus in case of a crash or sudden stop can be effectively reduced by the proper use of seat belts.



The hip/shoulder type seat belt should be worn correctly by the expectant mother. The shoulder belt should pass through the chest from a

proper position, and the hip belt should pass through the crotch as low as possible and fit under the raised abdomen. The seat belt must be flat to not compress the lower body of the expectant mother.

Please consult a physician for better advice.

Use of seat belt by disabled persons

The seat belt should also be worn correctly by disabled persons.

Please consult a physician for better advice.

Seat belt indicator

1. 指示灯 Indicator for unfastened driver's seat belt
2. 指示灯 Indicator for unfastened front passenger's seat belt
3. 指示灯 Indicator for unfastened rear left seat belt
4. 指示灯 Indicator for unfastened rear middle seat belt
5. 指示灯 Indicator for unfastened rear right seat belt



If the front passenger does not buckle their seat belt, the seat belt indicator on the dashboard will flash for several seconds before remaining illuminated when the vehicle is stationary. If the vehicle is in motion and reaches a certain speed, the seat belt indicator will light up, a warning message will appear, and an alarm will sound.

If a rear seat passenger does not fasten the seat belt, the corresponding seat belt indicator on the dashboard will flash for several seconds and then remain on.

If all occupants have fastened their seat belts and the indicator is still on, please re-fasten all seat belts to ensure that they are locked correctly.

Clean the Seat Belt

Pull out the seat belt and wipe it. After cleaning, air dry it before retracting.

caution

Do not use any type of cleaner or chemical cleaner to clean the seat belt surface.

Replacement of Seat Belt

If there is any sign of wear, cracks or other damages on the seat belt, please contact the XPENG Service Center to replace it. Do not replace the seat belt without authorization.

Warnings, Cautions and Limitations

- Seat belts must be worn correctly by all passengers including the driver when the vehicle is running. Failure to do so can easily increase the risk of injury or death in case of an accident.
- Never press the seat belt against fragile or sharp objects (such as pens, keys and glasses). The pressure generated by the seat belt on such objects may cause injuries.
- The seat belt must fit the body closely and not be twisted when it is in use. The shoulder



part of seat belt must go around the middle of the passenger's shoulder, and must stick to the upper body of the passenger and be tightened. The seat belt at the waist shall be as low as possible and go across the hips. If necessary, pull down the seat belt slightly. The seat belt can be adjusted by pulling it in the retracting direction.

- Each seat belt is only for use by one passenger or driver in the vehicle. Do not hold a child on his/her lap and share the seat belt with him/her.
- The seat belt shall not be affected by any chemicals, liquids and other substances. If the seat belt can not be retracted or can not be unlocked in the buckle, immediately contact the XPENG Service Center for maintenance.
- Never add unofficial additional items on the seat belt without authorization, including but not limited to the following: extra locking latch plate, strap stopper and buckle extension joint. These items may reduce or even deactivate the normal protection function of seat belts.

- The seat belt shall be fully retracted without overhanging when not in use. If the seat belt can not be fully retracted, immediately contact the XPENG Service Center for maintenance.
- The seat belts, seat belt retractor and seat belt fixing device shall not be removed, installed, modified or disassembled without authorization.

Airbag

Position of Airbag

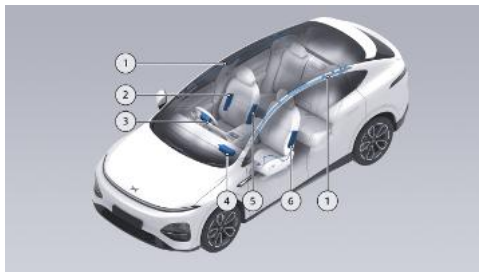



1. Front and rear head curtain airbags
2. Driver's seat side airbag
3. Driver airbag
4. Front passenger airbag
5. Driver's seat far side airbag
6. Front passenger's seat side airbag

warning

Airbags do not replace seat belts. The seat belt reduces the risk of serious injury or death in the event of an accident, whether or not the airbag is triggered, so the seat belt must be worn correctly. Airbags are only protected when triggered, and not all types of accidents trigger airbags.

Airbag malfunction indicator lamp

Once the vehicle is powered on, the “” indicator on the dashboard will illuminate for several seconds and then go out after the system completes its self-check. If the indicator does not go out after the system self-inspection

or lights up again after going out or stays on, it indicates a fault in the SRS. Please contact the XPENG Service Center immediately for maintenance.

Conditions and Situations for Deployment

Whether the SRS is deployed does not depend on the vehicle speed when an accident occurs, but depends on the crash strength collected by the crash sensor when an accident occurs. When the impact force of a crash is absorbed or dispersed to the body, SRS may not be deployed. However, depending on different impact conditions during an accident, SRS may also be deployed sometimes. Therefore, whether the SRS is deployed does not depend on the degree of damage to the vehicle.

The SRS may deploy in the following situations:

- The vehicle front end hits the ground when passing over a deep groove.



- The vehicle hits a curbstone or other protruding objects.
- The front end of the vehicle hits the ground when the vehicle is going downhill; or

The SRS may not deploy in the following situations:

- The vehicle hits a concrete column, tree, or any other long and slender object.
- The vehicle hits the lower rear of a large truck such as a truck.
- The vehicle encounters a rear-end crash with another vehicle.
- The vehicle rolls over or sideways.
- The vehicle hits a wall or vehicle on the positions other than the front end.

The deployed air bag and seat belt can provide protection for passengers including the drivers to reduce the risk of injury.

Impact after Deployment

At the moment of SRS deployment, a loud sound will be heard with the release of gas and powder. Such powder may irritate skin and eyes. At this time, on the premise of ensuring safety, escape from the vehicle as soon as possible. If it is impossible to do so, open the window or door and inhale fresh air.

If the powder caused by SRS deployment enters eyes or sticks to skin, rinse thoroughly with clean water as soon as possible. In case of serious discomfort, seek medical attention in time.

After the SRS is deployed, its volume will shrink to bring a progressive shock absorption effect to the driver and passengers, to ensure that the driver's front view is not blocked.



Airbag location

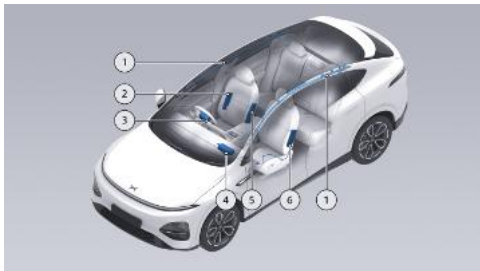

1. Front/Rear Side Curtain Airbag
2. Driver seat side airbag
3. Driver airbag
4. Passenger airbag
5. Driver Far-End Airbag
6. Passenger seat side airbag

warning

Airbags are not a substitute for seat belts. Whether or not the airbags are deployed, seat

belts do not reduce the risk of serious injury or death in an accident, so they must be worn correctly. Airbags only protect when they are deployed, and not all types of accidents will trigger airbags.

Airbag Warning Light

After the vehicle is powered on, the indicator light “” on the meter will light up for a few seconds, the system will go out after completing the self-check. If the indicator light does not go out after the system self-check or turns on again or stays on after going out, it means that there is a fault in the airbag system. Please contact the Xpeng Motors Service Center immediately for inspection.

Warnings, Cautions and Limitations

- The SRS can only be triggered once. Contact XPENG Service Center for replacement of the triggered SRS and any affected system components as soon as possible.



- After an accident, even if the SRS is not triggered, the SRS and its related systems may also have a fault. Please contact the XPENG Service Center for maintenance.
- The XPENG Service Center has dedicated tools, OBD device, repair information and qualified professional technicians. Vehicle repair and modification should be carried out by the XPENG Service Center.
- Do not use the SRS components removed from scrapped vehicles or recycled SRS components.
- Do not place any object within the SRS inflation range of the driver/front passenger seat, to avoid hindering the SRS inflation in case of frontal crash.
- The front passenger shall not hold children, pets or objects in his/her arms to occupy the SRS inflation space. This is mandatory for both adults and children.
- Do not attach any object (such as portable navigation device) to the front windshield above the SRS at the front passenger seat.
- Do not cover or paste any object (such as a phone holder and decoration) on the identification surface of the steering wheel or the front passenger side SRS components, or make any modification to the above parts.
- Do not stack objects on the front passenger seat. In case of emergency stop, once the airbag is deployed, the objects may be ejected and injure the driver and passengers.
- Do not use seat covers. Otherwise, deployment of the front-row side SRS will be restricted in case of an accident and detection accuracy of the system will also be reduced.
- Do not modify the airbag cover or add parts near it. Passengers should not rest their heads on the doors. Otherwise, when the curtain airbag is deployed, it may cause injury.
- Passengers are not allowed to put their feet, knees or any other body parts above or near the SRS, to avoid obstructing the normal operation of the SRS or causing fracture or other injuries during deployment of the SRS.



- Do not load or place any object above or near the driver/front passenger seat SRS, on the side of the front seat, above the roof at the side of the vehicle, and on any other airbag cover that may interfere with the deployment of the SRS. These articles may cause serious injuries when the SRS is deployed due to a violent crash.
- Do not try to change the SRS components, circuits and software. Otherwise, the SRS may fail to work normally and provide necessary protection for the driver and passengers, or it may fail to be deployed or deployed accidentally in case of an accident, increasing the risk of injury.

Children Passenger

Introduction

To ensure the safety of children, please use proper child safety seats based on their age, weight, and height. Please strictly follow the

instructions provided by the child safety seat manufacturer.

Older child in vehicle

If children are too big to use child safety seats, but too small to safely use standard seat belts, a child booster cushion that meets relevant regulations or standards can be purchased and used correctly. The child booster cushion can be used to raise the child, so that the shoulder belt of the seat belt will just cross the middle of the shoulder and lower the seat belt to the crotch.



Child Safety Seat Use Label



warning

Do not place a rearward-facing child seat on an airbag-protected seat, as this could cause death or serious injury to a child in the seat.

Front passenger airbag disabling

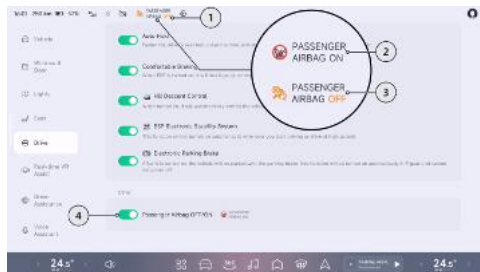

1. Front passenger airbag status indicator
2. Front passenger airbag on
3. Front passenger airbag off
4. Front passenger airbag switch

The front passenger airbag is on by default and can be turned off/on in the following two ways:

1. Tap the front passenger airbag status indicator on the status bar, then go to the switch setting interface.



2. On the central control screen, go to “ →**Drive**” interface, and you can slide down and tap the front passenger airbag switch.

warning

- Do not place a rear-facing child seat on the seat with an active frontal airbag. Death or serious injury to the child in the seat can occur.
- Be sure to select an appropriate child safety seat for the child based on his/her age, height and weight.
- One child seat is for only one child. Never constrain multiple children into one child seat with the seat belt.

- Under no circumstances should a child or infant be carried in the occupant's arms during driving.
- Never leave a child unattended in the child seat.
- Never leave children unprotected in a vehicle. Always keep children in the correct seating position during driving. Never stand in the vehicle or kneel on the seat. If an accident occurs under these circumstances, it could be fatal to children and others.
- Any child seat that has been applied forces in an accident must be replaced.

Recommended Types of Child Seats*

Both ECE-R44 and ECE-R129 standards apply to child seats in the country where the user is located.

ECE-R129 classification is based on a child height.

Child stature	Manufacturer	Type	Accessory
40 cm-105 cm	Dorel Europe	Maxi-Cosi Pearl 360 & FamilyFix 360 base	ISOFIX+Support Leg

Reassuring Travel



61 cm-105 cm	HTS BeSafe	iZi Kid X3 i-Size	ISOFIX+Support Leg
100 cm-150 cm	Britax Romer	Kidfix i-Size*	ISOFIX+Belt

*. For the best protection, it is recommended to use this child restraint system with the included backrest and be sure to attach the seat belt through Secure Guard and XP-pad.

ECE-R44 classification is based on a child weight.

Child weight	Manufacturer	Type	Accessory
22 kg-36 kg	Graco	Booster Basic	Belt

Only a child seat that is compliant might be used in the vehicle.

	Seating position						
seating position	front left	front centre	front right ①		2nd row left ②	2nd row centre②	2nd row right②
			with front passenger airbag on	with front passenger airbag off			



Seating position suitable for universal belted(yes /no)	No	No	Yes Forward facing only	Yes	Yes	Yes	Yes
I-Size seating position(yes/no)	No	No	No	No	Yes	No	Yes
Seating position suitable for lateral fixture(L1/L2)	No	No	No	No	No	No	No



Largest suitable rearward facing fixture(R1/R2X/R2/R3)	No	No	No	No	R1/R2X/R2/R3	No	R1/R2X/R2/R3
Largest suitable forward facing fixture(F1/F2X/F2/F3)	No	No	No	No	F1/F2X/F2/F3	No	F1/F2X/F2/F3
Largest suitable booster fixture(B2/B3)	No	No	(B2/B3)*	(B2/B3)*	B2/B3	(B2/B3)*	B2/B3



- *Only applicable for installation with seat belt.
- During the installation of the CRS, the backrest angle of seats should be adjusted reasonably to ensure that the CRS remains stable.
- During the installation of the CRS, the height of the headrest should be adjusted reasonably or the headrest should be removed to avoid interference with the CRS. Do not remove the head restraint when using a booster cushion with no backrest.
- ①: When installing a CRS on the front passenger seat, adjust the front passenger seat as high as possible to securely install the CRS.
- ②: When installing a CRS on the 2nd row seat, the frontal seats can be adjusted in fore/aft and height, and the seatback angle can also be adjusted to ensure there is no interaction with the CRS/child.



Installation of Children Safety Seat

Secure the child safety seat with the seat belt



1. Position the child safety seat on the rear outer passenger seat, then pull the seat belt out completely. Secure and buckle the seat belt as instructed by the child safety seat manufacturer.
2. Allow the seat belt to retract, firmly push the child safety seat into the car seat, and simultaneously tighten the loosened seat belt.

3. If the child safety seat has an upper tie-down ring, attach it to the backrest.

Installation of child safety seat through ISOFIX anchorage



The ISOFIX anchorage points are positioned between the backrest and the seat cushion on either side of the rear seat, each marked with the ISOFIX logo above.



The upper anchorage points are positioned behind the backrests of the rear seats.



1. Place the child safety seat on the rear outer passenger seat.





2. Insert the lower fixing bracket of the child safety seat into the ISOFIX anchorage as per the manufacturer's instructions.

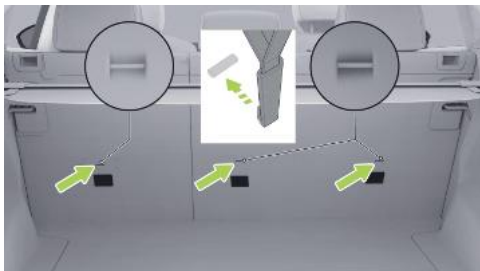

3. Pass the top fixing belt of the child safety seat through the headrest and pull it to the rear of the backrest. Connect the hook and loop of the fixing belt to the anchoring point, and tighten the fixing belt.

Check of child safety seat

Make sure that the child safety seat is not loose after installation:

1. Fix the child safety seat along the route of the seat belt. Try to slide the child safety seat from one side to another and from front to back.
2. If the child safety seat can move more than 2.5 cm, the child safety seat is too loose. Then fasten the seat belt or reconnect the ISOFIX child safety seat.
3. If it cannot be fastened, try other seat positions or use another child safety seat.

warning

- Do not place a rearward-facing child seat on an airbag-protected seat, as this could cause death or serious injury to a child in the seat.
- Always use a suitable child seat for the child's age, height and weight.
- A child weighing more than 9kg can only use a forward-facing child safety seat if he or she is able to ride independently. Children under two years of age have not yet



developed their spine and neck sufficiently, and avoid frontal impact damage.

- Under no circumstances should a child or infant be held in the arms of the vehicle and all children should be restrained in an appropriate child safety seat at all times.
- Do not leave a child alone in the vehicle, even if the child is secured to the child seat.
- Do not ride without safety protection, keep the child seated correctly when driving, and do not stand in the vehicle or kneel on the seat. Failure to do so could result in fatal injury to children and others in the event of an accident.
- Do not use the seat belt extension belt on the seat belt used to mount a child seat or booster seat.
- Make sure that the child's head is supported and that the child seat belt is adjusted and secured appropriately when a large child is traveling. The shoulder belt must be clear of the face and neck, and the lap section must be clear of the abdomen.

- Only one child can be accommodated in a child seat. Do not use the seat belt to tie more than one child to a child seat.
- Do not tie the two child safety seats to one anchor point. In the event of a collision, one anchor point may not be sufficient to secure both seats.
- The anchor points of the child protection unit are only loaded from the properly installed child protection unit. Under no circumstances should child protection be used with adult seat belts, harnesses, or other items or equipment.
- Always check the seat belt and tether strap for damage and wear.
- Never use a modified, damaged, or damaged child seat that has been involved in a vehicle accident. Check or replace the child seat as specified in the child seat manufacturer's instructions.
- To ensure that children ride safely, always follow all instructions detailed in this manual

Reassuring Travel



and the instructions provided by the child safety seat manufacturer.

Baby-on-Board Mode

Child safety locks are installed on both rear doors of the vehicle. After the child safety lock is activated in Baby-on-Board Mode, the corresponding door cannot be opened through the electric release switch, which can prevent children from opening the rear door by mistake. The window lock can also be enabled to lock the passenger windows glass lifter and reduce the accident risk during riding.



- On the central control screen, go to “ → **Window & Door** → **Baby-in-Car Mode**” interface, and you can turn on or off the window lock and child safety lock.
- Child safety locks can be enabled/disabled via the shortcut panel on the central control screen.

Tips

- It is recommended that the child safety lock is activated when the child is sitting in the rear row.



- To ensure safety when children are in the vehicle, lock the passenger glass up and down to prevent children from operating the windows to avoid pinching.

warning

The corresponding door cannot be opened from inside when the child safety lock feature is on, do not leave a child alone in the vehicle.

Alco Lock*

Introduction

This vehicle features an ALCO Lock port to accommodate an LIN interface alco lock (compliant with the 50436-4 2022 version standard).

Low-speed Simulation Sound AVAS

Introduction

When the vehicle is moving at a speed of less than 30 km/h, an analog sound will be emitted to alert nearby pedestrians and vehicles.

Operation

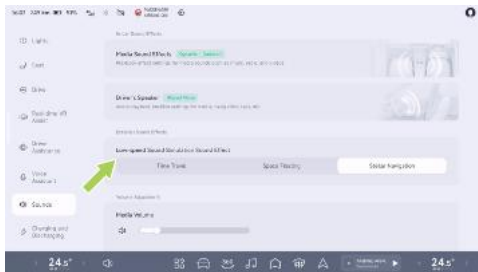

On the central control screen, go to “ Sounds” interface, and you can select “**Low-speed Sound Simulation Sound Effect**”.



Tire Pressure Monitoring System (TPMS)

Introduction

The TPMS can monitor the tire pressure and temperature in real time when the vehicle is running, and give an alarm in case of abnormal tire pressure, tire temperature or TPMS system, to ensure driving safety.

warning

- The instrument cluster tire pressure monitoring system warning lamp illuminates when there is an abnormal tire pressure or TPMS, and a corresponding text pops up to alert you: **“Low tire pressures, Reinflate in time”**, the **“tire pressure is too low, Refill immediately”**, **“tire pressure monitoring system fault, Contact Service”**, Please follow the word reminders.
- Private modification of the tire pressure monitoring system is prohibited.

Operation

The tire pressure will be automatically calibrated after each tire replacement. Before calibration, please keep the vehicle stationary for more than 17 minutes. During calibration, please drive at a speed of more than 40 km/h for 10 minutes and avoid reversing.

Braking Assist

Introduction

Electronic Stability Program (ESP)

The Electronic Stability Program uses sensors to identify vehicle driving states (e.g., understeer, oversteer, or drive wheel slippage), and can apply targeted braking intervention or limit drive torque to effectively reduce the risk of sideshow or tailspin to ensure vehicle driving stability.

Opening and closing

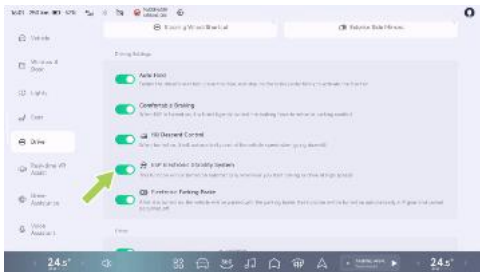

On the central control screen, go to “ → Drive” interface, and you can enable or disable “ESP Electronic Stability System”.

warning

- ESP does not prevent accidents caused by dangerous driving or high speed emergency steering.
- If the ESP fails, contact the XPENG Automobile Service Center immediately for service.

Anti-lock Braking System (ABS)

The ABS prevents the wheels from locking when the maximum brake force is applied. Under most road conditions, the steering control performance of the vehicle can be improved during an emergency stop.

In case of an emergency stop, ABS continuously monitors the speed of each wheel and adjusts the brake pressure based on the locking condition.

When ABS activates, you may feel brake pedal vibrations. You don't need to panic, and just simply drive according to the road conditions.

In the event of an ABS fault, the basic braking function remains normal and unaffected by the fault, but the braking distance will increase.

warning

The driver should always maintain a safe distance from the vehicle in front and be aware of dangerous driving conditions. Although ABS can improve the braking distance, it does not



go beyond the laws of physics, nor does it prevent the danger of tire slippage (e.g. when there is a layer of water between the road and the tire that prevents the tire from contacting the road directly).

Emergency stop

In an emergency, fully press the brake pedal and maintain steady pressure. ABS adjusts the brake pressure on each wheel based on the available brake force to prevent wheel lock-up and ensure a safe stop.

Traction Control System (TCS)

When the vehicle starts or accelerates rapidly on a slippery road surface such as ice and snow, the driving wheels will slip. dTCS controls brake pressure and vehicle torque output to minimize wheel slip.

i Tips

When the vehicle is in a situation where it needs to be trapped (e.g. in muddy or deep snow), the dTCS function can control wheel

slip while at the same time ensuring sufficient drive torque to help the vehicle clear, control the depth of the accelerator pedal to avoid being fully depressed at all times.

Electronic Brakeforce Distribution System (EBD)

The EBD is a part of the ABS. When the vehicle brakes normally, the EBD can balance the distribution of braking force between the front and rear wheels according to the vehicle load.

The EBD can properly distribute the brake force generated by the brake system to four wheels based on the traction between the wheels and the road surface. This ensures maximum braking efficiency, significantly shortens the braking distance, keeps the vehicle stable during braking, and improves driving safety.

Brake Assist System (EBA)

In case of emergency, quickly press and hold the brake pedal. The EBA will generate a braking pressure greater than that during normal braking,



so that the brake system can produce the pressure required for maximum deceleration in the shortest time, thus obtaining the shortest braking distance.

Hill Hold Control (HHC)

When the vehicle stops and starts on a hill with a slope of more than 5%, during the period when the driver releases the brake pedal to press the accelerator pedal, the power output is not enough to start the vehicle. Before moving forward (the vehicle tends to slide), the HHC will maintain the braking force required by the driver to stop the vehicle and keep the vehicle in a static state, to prevent the vehicle from sliding.

i Tips

- The HHC only applies to: When the vehicle is in D or R, the brake pedal is pressed and the amount of braking force produced before the brake pedal is released is sufficient to keep the vehicle on a hill.

- The HHC lasts approximately 2s and the brake hold time is released early depending on driver and grade.

! warning

The HHC is capable of providing brake assistance, but not exceeding the rules of kinematics, and for safety reasons, the driver should, depending on the vehicle, Apply the brakes in a timely manner to avoid an accident when the vehicle is rolling off a slope.

Multi-Collision Brake (MCB)

In the event of a vehicle collision, MCB can actively brake to reduce the likelihood of a secondary collision.

Hill Descent Control (HDC)

Introduction

The HDC is a cruise control function, which can help the driver drive downhill at a constant speed and relieve foot fatigue caused by



pressing the brake pedal all the time when driving downhill.

Operation

Enabling or disabling on the central control screen

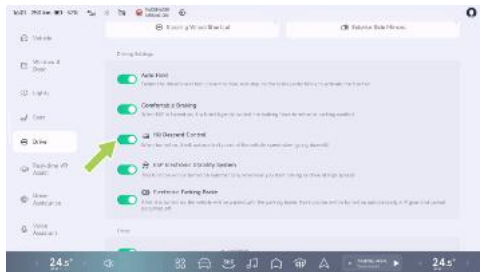

On the central control screen, go to “ → Drive” interface, and you can turn on or off “**Hill Descent Control**”.

The HDC function can be used when the vehicle speed is between 8 km/h and 35 km/h. If

you press the brake pedal or accelerator pedal during HDC operation, the HDC function will exit, and the driver needs to take control of the vehicle. When the vehicle speed exceeds 60 km/h, the function will fully deactivate and will not re-engage.

Tips

- HDC can be operated on gradients of 5% or more.
- HDC is switched on: Vehicle speed less than 35km/h; brake disc temperature is normal. The ESP system is OK.

warning

HDC can actively keep the vehicle's speed down, but not beyond the dynamics, and for safety reasons, the driver should follow the actual conditions of the vehicle. Apply the brakes in a timely manner to avoid an accident when the vehicle is downhill too quickly.



Quick Vehicle Locating

Introduction

When the vehicle cannot be found, this function can be used to locate it.

Operation

Long-distance vehicle locating

When you are far away from the vehicle or do not know where the vehicle is parked, you can go to the “XPENG” interface in your mobile app to query the geographical location information of the vehicle.

Tap the location information to view photos of the area surrounding the parked vehicle; tap the camera to view video around the vehicle; tap navigation to generate a path to locate the vehicle.

Close-range vehicle locating

Use the mobile App interface to operate close-range vehicle locating.

When you are close to the vehicle (for example, a residential parking lot), in the mobile APP, select the “XPENG” interface or “**Vehicle Location/Map**” interface, and choose the prompt via horn or flash so that you can quickly find the vehicle.

i Tips

- Only the owner's account number can view the vehicle's live location.
- A poor vehicle network may result in the vehicle seek function not functioning properly.
- When the vehicle is locked away, the system automatically captures photographs of the vehicle's perimeter, and de-sensitizes and encrypts them to protect the user's privacy.

Unlocking/Locking Feedback

Introduction

When the vehicle is unlocked, the doors unlock in sync; the turn signal lights on both sides of the vehicle will flash twice; the horn will sound



or chord music will play (if set); the front door handle will extend (if set); the side mirrors will open (if set); and the anti-theft alarm system will be deactivated.

When the vehicle is locked, the doors lock in sync; the turn signals on both sides of the vehicle will flash once; the horn will sound or chord music will play (if set); the front door handle will retract; the side mirrors will fold (if set); the windows will close (if set); and the anti-theft alarm system will be activated.

Operation

You can configure the feedback method for unlocking or locking the vehicle through the central control screen:

- On the Central control screen, go to “ →**Window & Door**” interface, and you can select methods for unlock and lock feedback respectively: “**Flash Lights**,” “**Flash + Horn**,” and “**Flash + Chord**”.

You can set the way enable or disable Pop-out Handles on Unlock through the central control screen:

- On the central control screen, go to “ →**Window & Door**” interface, and you can turn on or off the “**Pop-out Handles on Unlock**” function.

You can set the opening and closing mode of side mirrors when the vehicle is locked through the central control screen:

- On the central control screen, go to “ →**Drive**→**Exterior Side Mirrors**” interface, and you can turn on or off “**Fold Side Mirrors automatically after vehicle locking**”.
- On the shortcut panel, tap “**Side Mirror Adjustment**”. On the “**Side Mirror**” interface, you can turn on or off “**Fold Side Mirrors automatically after vehicle locking**”.

You can set the opening and closing mode of the windows when they are locked through the central control screen:



- On the central control screen, go to “ → **Window & Door**” interface, and you can turn on or off “**Close Windows Automatically after Vehicle Locking**”.

Anti-theft Alarm System

When the anti-theft system is activated and any door (including trunk) or front hood is opened, the anti-theft system will give an alarm through the horn and turn signal. The alarm of the anti-theft system can be deactivated after unlocking the vehicle.

Tips

The anti-theft system alarm lasts for approximately 28 seconds and is re-timed if the doors (including the boot) or the front compartment lid are opened again.

warning

Modifications to the vehicle anti-theft system are prohibited, as this may result in the system not functioning correctly.

NFC Card Key

Introduction

The NFC card key supports unlocking, locking, and starting the vehicle.

Operation

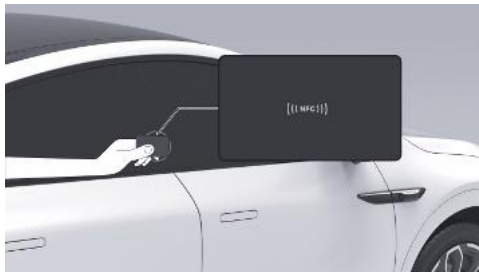

1. Door unlocking

- When the vehicle is locked, hold the Near Field Communication Card Key close to the NFC sensor area on the driver's side B-pillar for approximately one second. At this



point, the vehicle will provide an unlocking feedback prompt [See 193 page](#), indicating that the unlocking is successful.

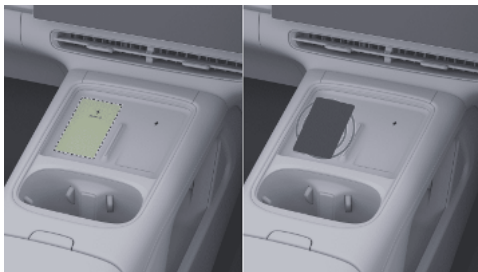

2. Start the vehicle

- Within 30 seconds of using the Near Field Communication Card Key, you can press the brake pedal and shift gears to start the vehicle.
- If the vehicle cannot be started within 30s, the central control screen will pop up a prompt window indicating **""Key not detected""**. Please place the Near Field

Communication Card Key in the wireless charging area on the driver's side (marked by the dotted line) for re-authentication. Once the card key fob is detected, the 30-second authentication timer will reset. Upon successful authentication, you can start the vehicle by pressing the brake pedal and shifting gears.

3. Walk-away lock

- When the vehicle is unlocked and all doors (including the front hood and trunk) are closed, hold the Near Field Communication Card Key close to the NFC sensing area on the driver's side B-pillar for approximately one second. At this point, the vehicle will provide a locking feedback prompt [See 193 page](#), indicating that the locking is successful.

i Tips

- Do not bend, twist or cut the NFC card key;
- Do not place the NFC card key in a hot place (e.g. instrument console);



- Do not place mobile phones or other metal objects in the wireless charging area of your phone when you start the vehicle using the NFC card key;
- Do not place the NFC card key in the wireless charging sensing area when using the mobile phone wireless charging feature.

Smart Remote Key

Introduction

The vehicle is equipped with a smart remote key, supporting both button operation and Auto Unlock or Lock

Operation

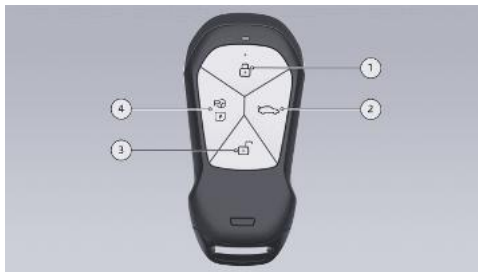

1. Lock button

Short press this button, and the vehicle will display a locking feedback prompt [See 193 page](#), indicating that the locking is successful.

i Tips

- The vehicle will not lock unless the vehicle is in P and all doors (including the front compartment lid, the boot)



are closed, unless the vehicle is left unattended.

2. Trunk open/close button

Double-click this button to open or close the trunk. Pause the opening or closing of the trunk.

3. Unlock button

Press this button, and the vehicle will display an unlocking feedback prompt [See 193 page](#), indicating that the unlocking is successful.

4. Parking & Charging port cap on or off Button

- Double-tap this button to open or close the charging port cap.
- Assist with the use of parking-related functions.

Replacement of smart remote control key battery



1. Press the trim cover unlock button and remove the trim cover in the direction of the arrow.

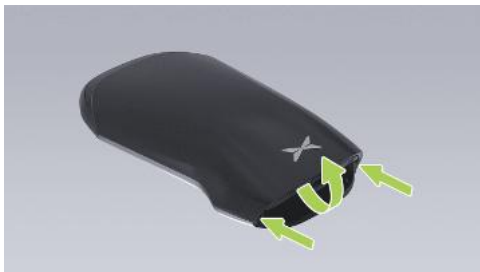

2. Pry up the edges on both sides of the rear cover with a suitable tool, then lift and remove the middle part of the rear cover.



3. Rotate the key battery cover plate counterclockwise along the arrow direction and remove the key battery cover plate.



4. Take out the key battery. Battery model: CR2450.
5. Install it in reverse order. During installation, keep the “+” (positive pole) of the key battery facing upward.

Mobile App Key

Introduction

After installing the XPENG App, you can register mobile phones as vehicle keys and utilize Bluetooth and NFC technologies for

communication. This enables convenient and secure locking/unlocking, starting the vehicle, and additional controls.

The XPENG App supports the following three types of keys:

- Mobile Bluetooth Key

Applicable devices: iOS and Android phones.

i Tips

After turning on the key, change the different system phone log on or uninstall the app, all can automatically sync the key, no need to turn on again.

- Mobile NFC key

Compatible devices: phones with Android that support NFC.

i Tips

Once the key is activated, The NFC default swipe app needs to be set to “**XPENG Automobile app before**”it can be used.



Mobile Bluetooth key

In the XPENG App, go to “**Digital Key**”, tap “**Activate**” under Bluetooth key, and operate according to the prompt of the XPENG App to create a mobile Bluetooth key.

Bluetooth key locking or unlocking

Bluetooth key: It supports two modes for locking and unlocking operations.

- **Manual unlocking and locking:** Once the mobile phone is successfully paired with the vehicle via Bluetooth, you can use the XPENG App to unlock, open or close windows, and open the trunk, etc.
- **Automatic unlocking and locking:** In the XPENG APP, turn on the “**Automatic unlocking and locking**” switch. After the mobile phone is successfully paired with the vehicle's Bluetooth, you can automatically unlock the vehicle when you bring your mobile phone close to the vehicle. The vehicle will automatically lock when you carry the key away from the vehicle.

caution

Do not close the XPENG Car app after unlocking, keep the XPENG Car App in the background. to determine the 手车 position of the machine in relation to the vehicle, 而行自 Unlocking from a slave, To ensure proper functionality 用, Be sure to turn on the following permissions for the XPENG Motors app:

Android phones

1. Blue 牙 permission
2. Autostart permission
3. Background Operations 行 privileges

IOS system phone

1. Location information needs to be set to always allow
2. Background App Refresh
3. Location Services (手 Machine Settings > Privacy > Location Services)



Mobile Phone NFC Key

In the XPENG App, go to “**Digital Key**”, tap “**Activate**” under NFC key, and operate according to the prompt of the XPENG App to create a mobile NFC key.

i Tips

This feature is only available on phones with Android 9.0 and above and NFC hardware.

Unlocking or starting the vehicle with the NFC key

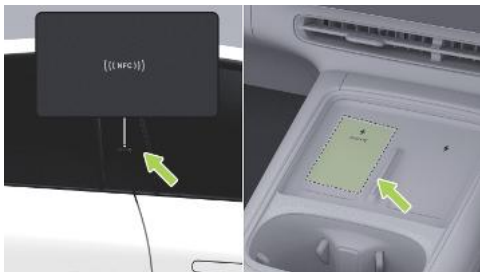

The procedure for unlocking, locking, and starting with the mobile phone NFC key is identical to that with an NFC card. Please refer to the details provided [See 195 page](#). Once you have opened the XPENG App, simply place your mobile phone near the NFC recognition area on the B-pillar to unlock or lock your vehicle. After verification, when your phone is placed near the vehicle's interior NFC area, you can press the brake pedal and shift gears to start the vehicle.

i Tips

- When unlocking with an XPENG Auto key, the XPENG Auto default payment app needs to be set to the XPENG Auto app, otherwise NFC will not work properly.
- When unlocking/starting the vehicle using the NFC key, the phone screen will need to be unlocked. The phone may be turned off or the screen will not work properly, which may result in the NFC key not being used.



- Keep the back of your phone close to the NFC sensing area as much as possible, depending on the back of your phone.

Deactivation of Digital Key

On the central control screen, go to “ → **General** → **Safety and Privacy**” interface, tap “**Deactivate Digital Vehicle Keys**”. In the pop-up window, tap “**Confirm to Send**” to send a verification code to the vehicle owner's phone number. After the driver enters and verifies the code, all users' digital vehicle keys will be deactivated.

Tips

When the digital key is deregistered, all authorized users are required to re-activate the digital key and should be used with caution.

Mobile NFC key

In the Xpeng Motors App “**Digital Key**” tap the NFC key “**activate**” button, follow the prompts on

the Xiaopeng Motors App to create a mobile NFC key.

This feature is only available for Android 9.0 and above operating systems and phones with NFC hardware.

NFC key unlocks/starts the vehicle

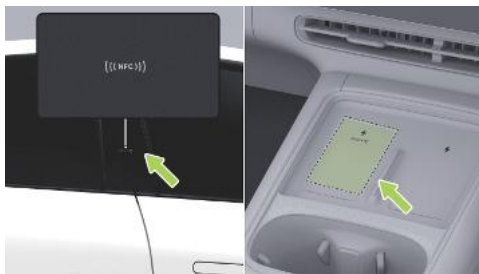

The operation method of unlocking, locking and starting the mobile phone NFC key is the same as that of the NFC card. See 195 page After opening the Xiaopeng Motors App, you can unlock and lock the vehicle by placing your



phone close to the NFC recognition area on the B-pillar; after completing the key authentication by placing your phone close to the NFC recognition area inside the car, you can start the vehicle by pressing the brake pedal and shifting gears.

i Tips

- When using the NFC key to unlock the car, you need to set the NFC default payment application to the Xpeng Mobile App, otherwise NFC will not work properly.
- When using the NFC key to unlock/start the vehicle, you need to unlock the phone screen. If the phone is turned off or the screen is off, the NFC key may not work properly.
- The NFC position on the back of different phones is different. Please try to keep the back of the phone close to the NFC sensing area.

Warnings, Cautions and Limitations

1. In which Combos (including but not limited to) might the Bluetooth key's automatic lock/unlock function fail?
 - When the phone has low battery or is in power-saving mode.
 - The Bluetooth capability on the mobile phone is deactivated.
 - When the phone's system has turned off the XPENG App.
 - When the Bluetooth signal is unstable or disconnected abnormally.
 - When obstacles (such as backpack, body, and walls) block the Bluetooth signal, causing abnormal distance measurement.
 - After restarting the phone or updating the system, if the XPENG App hasn't been reopened.
 - When the vehicle's door, front hood, or trunk is not fully closed and the Bluetooth connection is lost when leaving the vehicle.



2. In which Combos (including but not limited to) does the mobile phone's NFC key fail to lock or unlock?
- When the phone has low battery or is in power-saving mode.
 - The NFC capability on the mobile phone is deactivated.
 - The default payment application on the phone is not set to the XPENG App.

i Tips

When the mobile phone Bluetooth key fails to unlock, please restart the XPENG Auto App first. If the problem is still not resolved, Please use the “**XPENG→Digital Key→key check**” screen, Follow the guidelines to resolve the connection issue.

Keyless Entry

Introduction

The keyless entry supports the following methods for locking and unlocking:

- Door Handle Capacitive Switch.
- Automatic locking and unlocking.

Operation

Door Handle Capacitive Switch

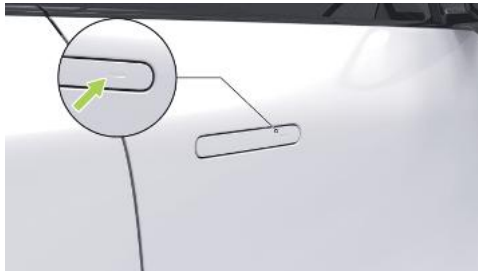



With the smart remote key or mobile Bluetooth key, you can touch the front door handle capacitive switch to unlock or lock the vehicle.

- **Unlocking the door:** When the vehicle is locked, touch the front door handle capacitive switch. At this time, the vehicle will display an unlocking feedback prompt [See 193 page](#), indicating that the unlocking is successful.
- **Walk-away lock:** When the vehicle is unlocked and all doors (including the front hood and trunk) are closed, touching the front door handle capacitive switch will trigger a locking feedback prompt [See 193 page](#), indicating that the locking is successful.

Warnings, Cautions and Limitations

Bluetooth antenna position



1. Both sides of front bumper
2. Behind the front reading light
3. Both sides of rear bumper

Passengers with implanted cardiac pacemakers should keep a distance of at least 22 centimeters from the vehicle's Bluetooth antenna to avoid the Bluetooth antenna interfering with the function of the cardiac pacemaker.



Interior Unlocking and Locking

Introduction

You can lock or unlock the vehicle from inside the vehicle using the following methods:

- Vehicle door lock
- central control screen vehicle door lock
- Automatic Unlock when Parked

Operation

Vehicle door lock



The door lock switch is located on the driver's door armrest:

- Lock: When all doors (and the front hood and trunk lid) are closed, press this switch to lock the vehicle.
- Unlock: Press this switch to unlock the vehicle.

central control screen vehicle door lock

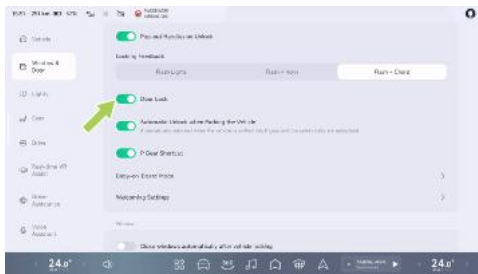

- On the central control screen, go to → **Window & Door** interface, and you can turn on or off **Door Lock**.

Entry and Exit



- At the bottom taskbar of the central control screen, tap “**Door Lock**” (if set), and you can lock or unlock the vehicle.



- On the central control screen, tap “**Real-time VR Assist**” in the APP Center or “**Real-time Virtual Reality Assist**” (if set) in the taskbar at the bottom of the central control screen to enter the Real-time Virtual Reality Assist interface. On the interface, tap the icon below the 3D vehicle model to unlock or lock the vehicle.

Automatic Unlock when Parked

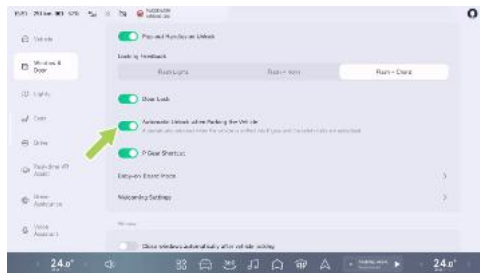

On the central control screen, go to “**Window & Door**” interface, and you can turn on or off “**Automatic Unlock when Parking the Vehicle**”.

When “**Automatic Unlock when Parking the Vehicle**” is enabled, doors unlock automatically after the vehicle shifts to P gear and the driver's seatbelt is unfastened.



i Tips

The door locks are also automatically opened/closed if certain conditions are met:

- 行车自 Dynamic locking: When the doors (including the boot) and the front compartment cover are closed, the door locks automatically lock if the vehicle speed is greater than 10 km/h.
- Automatic door unlock: The door is opened from inside the vehicle (front power release door button/emergency open) and the door lock is automatically unlocked.
- Automatic emergency unlocking: The door locks automatically when the vehicle is involved in a collision or in an emergency such as a thermal loss.

Hidden Electric Door Handles

Introduction

The vehicle features hidden electric door handles, which can be operated as follows:

- Unlock the vehicle via the front door handle capacitive switch [See 205 page](#).
- Set Pop-out Handles on Unlock.
- Unfold the door handle manually.

Operation

Set Pop-out Handles on Unlock

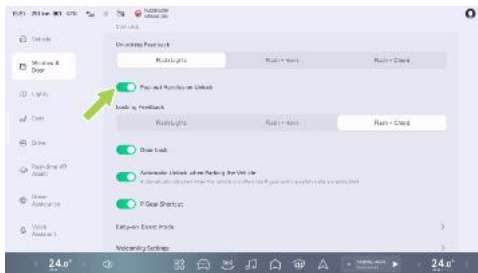



On the central control screen, go to “ → **Window & Door**” interface, and turn on “**Pop-out Handles on Unlock**”. When the vehicle is unlocked, the door handle will automatically pop

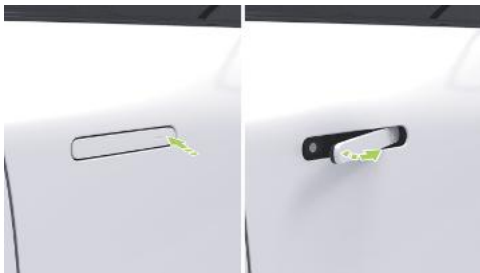

out, so that you can pull the handle to open the door easily.

Unfold the door handle manually



On the central control screen, go to “ → **Window & Door**” interface, and turn off “**Pop-out Handles on Unlock**”. When the vehicle is unlocked, the door handle will not automatically pop out. In this case, you need to press the front end of the door handle and pull the handle to open the door.

Automatic retraction of door handle

- Locking retraction: When the door is locked, the door handle will be automatically retracted.
- Retraction when changing gear: When the gearshift lever is switched from P to N/R/D, the door handle will be automatically retracted.
- Overspeed retraction: When the vehicle speed exceeds 3 km/h, the door handle will be automatically retracted.
- Timeout retraction: If the doors (including the trunk) and the front hood are closed and the retraction operation is not performed within 120 seconds, the door handle will automatically retract.

warning

When using the door handles, be careful that fingers, jewelry, acrylic nails, etc. are not trapped by the door or door handle mechanism. Failure to do so could result in damage to objects or personal injury.



i Tips

- When using the automatic parking feature, the flush door handle remains deployed, pulling the door handle suspends the automatic parking feature.
- Control the door handle fold/show more than 8 times within 1 minute, will trigger the anti-play mode, the door handle no longer moves, after 20 seconds the function will resume.

Opening/Closing of Electric Doors

Introduction

The electric door can be opened or closed by the following ways:

- Hidden electric door handles
- Electric door release button
- Emergency Opening Handle or Pull Ring
- Mechanical key

Operation

Via hidden electric door handles



When the vehicle is unlocked, the door can be opened using the hidden electric door handle.



Electric door release button



When the vehicle is stationary, press the electric door release button to open the door.

i Tips

When the vehicle speed is greater than 3 km/h, the door cannot be opened using the power release door button.

Front emergency door release handle



Pull the emergency opening handle under the front door armrest to open the door.

⚠ warning

The vehicle is stationary or driving, pulling the emergency opening handle once opens the door, non-emergency, do not pull the emergency opening handle while driving.



Rear emergency door release pull ring



1. Press to open the maintenance cover plate under the rear door armrest.
2. Pull the emergency door release pull ring to open the door.

warning

The vehicle is stationary or driving, pulling the emergency opening tab once opens the door, non-emergency, do not pull the emergency opening tab while driving.

Mechanical key



When the vehicle is out of power, press the front end of the concealed door handle and pull it out. Insert the mechanical key into the lock hole, rotate clockwise to unlock the door, and then pull the door handle to open the door.

Tips

- Only the main door can be opened using the mechanical key, when entering the vehicle, other doors can be opened using the emergency opening handle/ring.



- Make sure the mechanical key is fully inserted before turning the key. When unlocking, the mechanical key needs to be turned back to the home position to be removed. If the key does not turn during operation, insert the key fully to continue turning.
- In extreme cold weather, do not force the key out if the key does not return when using the mechanical key door. Please contact Xpeng Automobile Service Center.
- The mechanical key is supplied separately with the vehicle, so keep it safe to avoid loss.

- Mobile App key [See 200 page](#)
- Xpeng voice
- Steering wheel shortcut key (if set) [See 272 page](#)
- Central control screen
 - Shortcut panel
 - Bottom taskbar (if set)
 - Setting interface
- Emergency opening switch

Opening or Closing of Trunk

Introduction

The trunk can be opened or closed by the following ways:

- Trunk exterior switch
- Trunk interior switch
- Smart remote key [See 197 page](#)

Tips

When opening/closing the loadspace, the loadspace will retract a certain distance if an obstruction is obstructed.

warning

When opening/closing the boot, ensure that there are no persons or other obstructions within the open/closed boot area to prevent personal injury or vehicle damage.



Operation

Trunk exterior switch

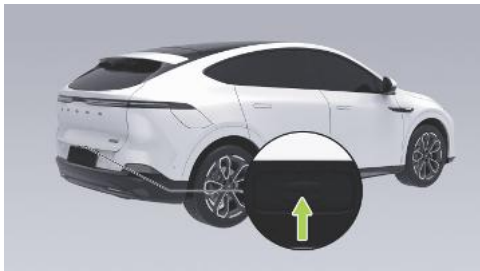

With the doors unlocked, you can press the trunk exterior switch to open or close the trunk, or pause the trunk that is opening/closing.

If the vehicle is locked, as long as you carry the key near the trunk, you can open the trunk.

Trunk interior switch

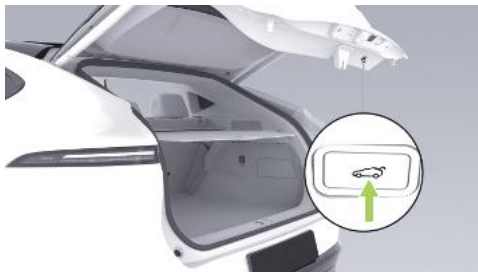

Press the internal switch to close the trunk, or pause the opening or closing of the trunk.

Entry and Exit



central control screen can open or close the trunk.

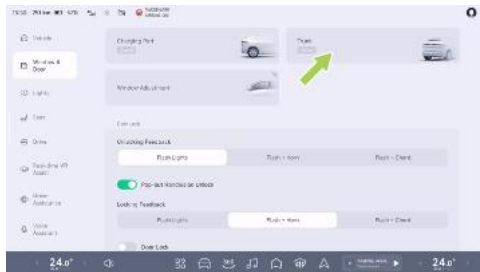

On the central control screen, go to “” → **Window & Door**” interface to open/close “**the Trunk**”. Tap again during movement will pause opening/closing.

In the taskbar at the bottom of the central control screen, tap “**Trunk**” (if set), and you can open or close the trunk.



On the central control screen, tap “”, and then tap “**Real-time VR Assist**” in the App Center or tap “**Real-time VR Assist**” at the bottom taskbar of the central control screen (if set) to enter the Real-time Virtual Reality Assist interface. On the interface, tap the icon below the 3D model to open or close the trunk, or rotate the 3D model to show a hotspot icon in the trunk area, and tap the hotspot icon to open or close the trunk.

Emergency opening switch

If the trunk cannot be opened, it can be opened by the following operations:



1. Put down the rear seat backrest and get into the trunk.



2. Press the upper latch of the trim cover on the emergency unlocking device to remove the trim cover.

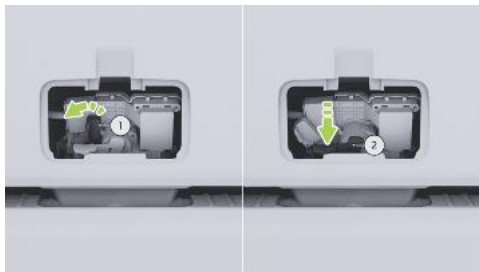

3. Pull the lever ① to the left and hold it, then press the lever ② to unlock the trunk, and then push the trunk outwards to open it in emergency.

i Tips

After emergency opening, press down on the boot to close it.

Adjustment of Trunk Deployment Angle

The vehicle supports two methods (central control screen and trunk internal switch) to adjust the trunk opening angle:



- On the central control screen, go to “ →**Window & Door**” interface, and you can adjust “**Trunk Unfolding Angle Memory**”.
- When the trunk is deployed to a desired angle, press and hold the trunk bottom switch until you see a flash prompt. At this point, the setting of the trunk deployment angle is completed.

Tips

When the switch is pressed and held, the loadspace deployment angle will be set to the lowest value if the loadspace deployment angle is below the minimum allowable setting.

Welcome

Introduction

On the central control screen, go to “ →**Window & Door**→**Welcoming Settings**”

interface, and you can turn on or off the following different welcome functions.

- Driver's seat welcome
- Front passenger welcoming
- Light Welcome
- Welcoming sound effect

Operation

Driver's seat welcome

When the driver's seat welcoming feature is enabled, the seat automatically slides back as the driver's door opens, easing your entry and exit from the vehicle. Upon entering and closing the door again, the seat returns to the memorized position.

On the central control screen, go to “ →**Window & Door**→**Welcoming Settings**” interface, and you can turn on or off the driver welcome function.



Front passenger welcoming

With the front passenger seat welcoming function activated, opening the front passenger door will cause the seat to slide back slightly, facilitating easier ingress and egress. Upon entering the vehicle and closing the door again, the seat returns to its saved position.

On the central control screen, go to “ → **Window & Door** → **Welcoming Settings**” interface, and you can turn on or off the passenger welcome function.

Tips

- If the seat back angle is greater, the seat back may affect the rear passengers and the approach function will not be activated.
- If the seat position is in a rearward position and the person has been able to exit the vehicle easily, the approach function will not be activated.

caution

Always make sure that there are no obstructions within the seat movement area before the seat approach function is activated, as personal injury or vehicle damage may result.

Light Welcome

When the remote physical key approaches the vehicle within 8 meters, the external welcome lighting effects will automatically activate.

On the central control screen, go to “ → **Window & Door** → **interface**, and you can **turn on or off the Light Welcome.**” Welcoming Settings

Tips

When the approach function is triggered, the system automatically exits the approach function if you operate the lights actively (e.g. low beam, high beam) or unlock the vehicle.



Welcoming sound effect

After the welcoming sound effect is enabled, once the driver enters and closes the driver's door, the vehicle will play music according to the selected interior welcoming sound effect.

On the central control screen, go to “ → **Window & Door** → **Welcoming Settings**” interface, and you can turn on or off the welcome sound effects. After the function is turned on, you can select the desired welcome sound effects.

Vehicle Power On and Power Off

Introduction

The vehicle can be powered on or off by the following ways:

- Open the door to power on.
- Lock the vehicle to power off.
- Emergency Power Off Switch is used to Power Off.

- Press the brake pedal to power on.
- Not power off during a temporary stop.

Operation

Open the door to power on.

Power on, if any door (excluding the trunk) opens when the vehicle is unlocked.

Lock the vehicle to power off

When the driver's seat is unoccupied, you can power off the vehicle after locking it from the outside.



Power off using the emergency power off switch



The following ways can be used for emergency power-off:

- When the vehicle is stationary, press and hold the emergency power-off switch for 5 seconds to directly power off the vehicle.
- When the vehicle is stationary or at a certain speed, press the emergency power-off switch continuously for 3 times within 2s to directly power off the vehicle.

i Tips

Pressing the emergency off switch for a long time at a vehicle speed requires confirmation at the instrument, and pressing it three times within 2 seconds, whether or not there is a vehicle speed will be directly powered down.

Press the brake pedal to power on

When the vehicle is powered off, if the Near Field Communication Card Key, remote control key, or phone key is placed inside the vehicle, press brake pedal to power on the vehicle.

No power off during temporary stops

When the “**Power Off Automatically**” function on the central control screen is turned off and the vehicle is in the power-on state, the gearshift lever is at the P position. Open the mobile APP, go to the “**XPENG**” interface, and tap “**Temporary Stop**”. In the pop-up prompt window, tap “**Confirm**”. The vehicle will be locked and the touchscreen and A/C will remain available.



Tips

If the “**automatic power down**” function is on in the CID and the conditions for automatic power down execution are met, the vehicle automatically powers down after one hour.

Power Off Automatically

On the central control screen, go to “ → **General** → **Security and Privacy**” interface, and you can activate or deactivate the “**Power Off Automatically**” function. A pop-up window to show a message of a 10-minute countdown to powering off automatically will appear on the central control screen. At this time, you can tap “**Cancel**” to reset the 1-hour countdown.

After the “**Power Off Automatically**” function is enabled, the vehicle will be automatically powered off when the following conditions are met at the same time.

- There is nobody seated in the vehicle.
- All doors (including the trunk) and the front hood are closed.

- The vehicle is in a parked state.
- No operations are performed within 1 hour.

Tips

In addition, the vehicle will power up/down automatically when certain conditions are met.

- System upgrade power up.
- 自 Power-up requested by the driving function.

Rear Seat Occupancy Reminder

Introduction

The rear seat occupancy reminder function offers a service that detects the status of the rear seats, seat belts, and other indicators to provide a reminder about items left in the rear row.

caution

This feature cannot be guaranteed to be completely accurate, look carefully at the rear



of the vehicle when leaving it and never leave children, people in need of assistance or pets alone in the vehicle.

Operation



On the central control screen, go to “ → **General** → **Safety and Privacy**”, and you can turn on or off the “**Reminder for Passengers Left in Rear Seats**” function. After the function is turned on, if any activity sign is detected on the rear seats, the driver will be reminded to check the rear seat when getting out of the vehicle.



Seat Adjustment

Introduction

You can adjust seats by the following means:

- Seat switch
- Central control screen setting interface
- Xpeng voice

i Tips

- If functions such as seat memory, seat approach, seat position, central screen adjustment are not used correctly, An initialization operation can be attempted.
- Small P voice cannot adjust the rear seat backrest.

Operation

Adjustment of driver's seat with seat switch



1. Backrest angle adjustment switch
 - Adjust the backrest angle: Push the top of the switch forward/backward.
2. Lumbar support adjustment switch
 - Adjust the lifting height of the lumbar support: Toggle the switch up or down.



- Adjust the forward and rearward position of the lumbar support: Toggle the switch forward or backward.
 - On the driver's seat adjustment interface of the central control screen, after the **"Steering Wheel Lumbar Support Adjustment"** function is activated, you can use the left scroll wheel to adjust the lumbar support height, and the right scroll wheel to move the lumbar support forward and backward.
3. Seat or cushion adjustment switch
- Horizontal adjustment of seat: Move the switch forward or backward.
 - Vertical adjustment of seat: Push the rear part of the switch upward or downward.
 - Cushion height adjustment: Move the front part of the switch upward or downward.
4. Headrest release switch
- Adjustment of headrest height: Push the headrest upward to raise the headrest;

press and hold the switch to lower the headrest.

- Removal of headrest: Press the switch and pull it upward to remove the headrest.

i Tips

- "The head restraint locks into position by clicking during head restraint adjustment.
- The lowest position of the head restraint is not its use position, always raise the head restraint to the locked position when using it.



Adjustment of front passenger's seat with seat switch

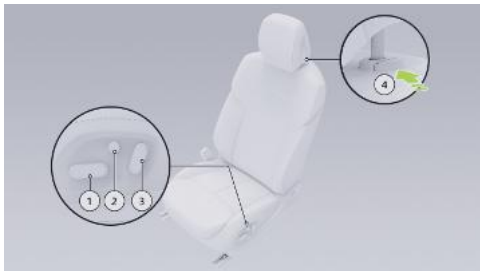

1. Seat adjustment switch

- Horizontal adjustment of seat: Move the switch forward or backward.
- Vertical adjustment of seat: Push the rear part of the switch upward or downward.

2. Lumbar support adjustment switch

- Adjust the upward position of the lumbar support by toggling the switch up or down.

- Adjust the lifting height of the lumbar support by toggling the switch forward or backward.

3. Backrest angle adjustment switch

- Adjust the backrest angle: Push the top of the switch forward/backward.

4. Headrest release switch

- Adjustment of headrest height: Push the headrest upward to raise the headrest; press and hold the switch to lower the headrest.
- Removal of headrest: Press the switch and pull it upward to remove the headrest.

i Tips

- “”The head restraint locks into position by clicking during head restraint adjustment.
- The lowest position of the head restraint is not its use position, always raise the head restraint to the locked position when using it.



Rear seat headrest height adjustment



Adjustment of headrest height: Push the headrest upward to raise the headrest; press and hold the headrest switch to lower the headrest.

i Tips

“The head restraint locks into position by clicking during head restraint adjustment.”

Fold down the backrest of the rear seat



1. Pull the backrest unlocking handle forward.
2. Fold the seat backrest forward.



3. To return the seat backrest, pull out the seat belt, lift the seatback upwards, then push it backward to lock it into place.

⚠ caution

When the seatback is lowered, remove the items from the rear seats to avoid interfering with the reclining effect.

Rear seat angle adjustment



Both sides of the rear seat cushion are equipped with handles for adjusting the seat backrest; pull them upward to alter the backrest angle.



Front seat adjustment via the central control screen

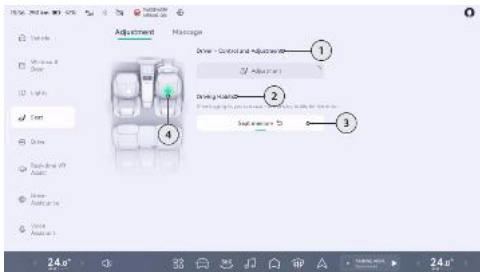

On the central control screen, go to “ → **Seat** → **Adjustment**” interface, and you can adjust the seat position.

1. Tap “” to select the seat to be adjusted.
2. Tap to enter the adjustment interface of the selected seat.
3. After logging in, enter the Driving Habits management interface to add Driving Habits or rename the habits.

4. Tap to recall the memory position of the selected seat.

Tips

- The host driver seat is used here and when clicked, recalls the memory position of the host driver seat and the rear view mirror.
- When a non-host seat is selected, a long press renames the memory position.

Seat position memory

1. Select the driver's or front passenger's seat on the Seat Adjustment interface of the central control screen.
2. Adjust the seat to a proper position.
3. Save according to central control screen prompts.

Seat initialization

Front seat initialization

If the seat functionality is abnormal (e.g., the seat cannot be adjusted by buttons, central control



screen, or voice command), you can try manually initializing the seat before use.

1. Push the backrest angle adjustment switch forward to move the seat's backrest to its foremost position. Hold the switch for 1 second before releasing.
2. Push the backrest angle adjustment switch forward again within 5 seconds, hold it for 7 seconds, then release. The seat will automatically initiate the initialization process.
3. Wait until the seat stops completely before using it.

Warnings, Cautions and Limitations

warning

- Care must be taken when adjusting the seat to ensure that the seat moves without injuring other occupants.
- The head restraint is not in use when it is in the lowest position and should not be adjusted to this position when an occupant is in the vehicle.

- Do not place your fingers or other body parts under the seat, as this may cause injury to the seat.
- Do not adjust the host seat while the vehicle is moving, as adjusting the seat will deviate from the correct seating position and can result in injury or death.
- Do not adjust the seat with the seat belt fastened, to avoid the seat belt being taken out of normal use, injury to occupants and loss of protection.

caution

Do not place overthicker floor mats or other foreign objects (such as beverage bottles, charcoal bags, etc.) on the bottom of the master/passenger seat, as they may become trapped between the seat and the guide rails, preventing seat adjustment. Locking, thus damaging the seat. It is recommended to use officially approved carpet mats from XPENG Motors.



Side Mirrors

Introduction

The side mirror offers the following adjustment functions:

- Adjust the angle of the side mirror using the buttons on the steering wheel
- Memory for side mirror position
- Unfold or fold side mirrors
- Auto tilting-down in reversing
- Automatic Mirror Folding while Locked

Operation

Access the side mirror adjustment interface

You can access the side mirror adjustment interface through any of the following methods:

- Xpeng voice
- Shortcut panel of central control screen [See 39 page](#)

- Bottom taskbar (if set) of the central control screen [See 38 page](#)
- On the central control screen, tap “ →**Drive**→**Exterior Side Mirrors**”.

Adjust the angle of side mirrors



Once the side mirror adjustment interface is open, use the scroll buttons and left or right buttons on both sides of the steering wheel to adjust the mirror angle.



warning

- Do not adjust the exterior mirrors while the vehicle is in motion to prevent accidents.
- Do not manually press the exterior mirrors to adjust the tilt angle.
- Do not make private modifications to the exterior mirrors.

Automatic downward tilting of side mirrors while reversing



On the Side Mirror Adjustment interface, you can turn on or off the **“Tilt down the left side mirror when reversing”** and **“Tilt down the right side mirror when reversing”** functions.

Once the function is activated, when the vehicle is in reverse gear (R), the side mirror on the corresponding side (with the auto tilting-down function preset) will tilt down to a specific angle to aid in reversing.

Tips

When the mirrors are turned down when reversing, the mirror angle can still be adjusted in the exterior mirror adjustment screen via the steering wheel scroll wheels and the left and right keys.



Side mirror Unfolding or Folding



1. Unfold or fold side mirrors
 - On the Side Mirror Adjustment interface, tap “**Side Mirror Fold**” to unfold or fold the external rearview mirrors.
2. Automatic folding upon vehicle locking
 - On the side mirror adjustment interface, you can enable or disable the Automatic Mirror Folding while Locked function. Once the function is activated, the side mirrors will automatically unfold when the vehicle is

unlocked and automatically fold when the vehicle is locked.

warning

When unfolding or folding the exterior mirrors, be careful not to pinch your fingers between the exterior mirrors and the base of the mirror.

side mirror heating

The side mirror heating function is used to heat the left and right side mirrors. It can quickly dry water spots or snow in rainy and snowy weather, thus enhancing driving safety. On the A/C Setting interface [See 263 page](#), tap “” to activate heating.

caution

Do not touch with your hands when the exterior mirror heating is on to avoid burns.



Warnings, Cautions and Limitations

side mirror reset

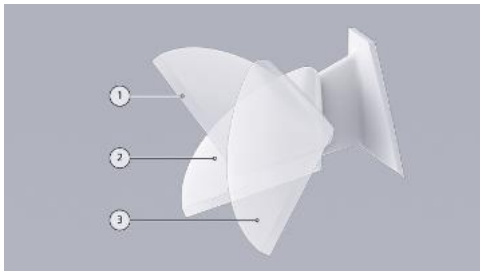

1. Forward folding
2. Standard state
3. Backward folding

When the side mirror is in the unfolded state, the side mirror may be folded forward or backward due to accidental impact or manual pushing. It can be restored to the normal position with the following operations.

1. You can set the side mirror unfolding feature on the central control screen via the following method:
 - On the Side Mirror Adjustment interface of the central control screen, tap “**Unfold**”.
 - On the shortcut panel of the central control screen, tap “**Unfold to unfold the review mirrors**”.
 - In the bottom taskbar of the central control screen, tap “**Rearview Mirror Unfold**” (if set).

i Tips

When the exterior mirrors are in a folded state, they can be folded forward or otherwise due to an accidental impact or manual push, which can be set on the CID.

2. Manually push the rearview mirror to normal position.

i Tips

Before manual reset, should check the folding surface for foreign objects such as snow and



ice, remove foreign objects before resetting, otherwise it can easily damage the exterior mirror fold structure.

Light Adjustment

Introduction

You can control lights by the following means:

- Left lever
- Central control screen
 - Shortcut panel (only supports automatic headlight on or off) [See 39 page](#)
 - Setting interface
- Xpeng voice

i Tips

Small P-voice does not switch on high beam and turn signals.

Operation

Left lever



- Turn signal: Pull the lever upward or downward gently, and it will return to the original position automatically after being released. In this case, the turn signal on the corresponding side will flash 3 times.
- Turn signal: Push the lever upward/downward to the top/bottom, then release, and it will automatically return to its original position. The turn signal on the corresponding side will flash.

Driving Operation



Push it to the lane change light gear or let the steering wheel return to its original position to turn off the turn signal.

i Tips

When the turn signal lights come on, the corresponding turn indicator is displayed on the instrument panel, accompanied by a 'click' sound.



- High beam: When the low beams are on, pull the lever forward to turn on the high beams; push it again to turn off the high beams.

- Overtaking lights: Pull the lever backwards continuously and release it, and the high beams will flash.

⚠ caution

For your safety and that of others, use high beam appropriately.

Central control screen setting interface

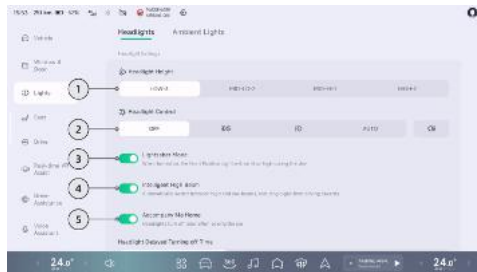

1. Headlight height:



- The headlight height can be set to suit vehicle driving and load adjustment according to the situation.

2. Headlight control:

- OFF: Click to deactivate all exterior lights.
- : Tap to turn on the position light and license plate light.
- : Tap to turn on the low beams.

caution

When the vehicle is moving in a dark environment, it needs to be confirmed twice on the central control screen to switch off the low beam.

- AUTO: Automatically activates/deactivates the high and low beams according to ambient brightness around the vehicle.

Tips

The central control shortcut panel can also turn the automatic headlights on/off.

- : Tap this button to turn on or off the rear fog lights. If the low beams do not illuminate, they will be turned on simultaneously.

3. Lightsaber mode: When enabled, a safety prompt window will appear. Please read the safety tips carefully. Tap **“OK”** to activate this function. Once activated, the front through-light will remain brightly lit during the daytime.
4. Intelligent high beam: Tap to turn on or off the intelligent high beam [See 253 page](#).
5. Accompany Me Home:
 - After activation, the "Accompany Me Home" function will be triggered once the vehicle is locked. You can set the headlight to go out after a delay of **“15s”**, **“30s”**, and **“60s”**.

Warnings, Cautions and Limitations

Headlight height adjustment

The headlight height suitable for vehicle driving and load adjustment can be set according to the situation, with reference as follows.



Condition	Headlight height position
Driver only	Maximum
Driver and one front passenger only	
There are five persons in the front and rear seats	Higher
Five persons on front and rear seats, with luggage in the trunk (within maximum permissible axle load and maximum permissible vehicle weight limits)	Relatively low
Driver only, with luggage in the trunk (within the limits of maximum permissible axle load and maximum permissible vehicle weight)	Lowest

caution

It is normal that under certain conditions of use, such as high air humidity or car washing, fog may occur within the lamp. If there is a large amount of water droplets or water in the lamp, contact the XPENG Vehicle Service Centre.

Wiper control

Introduction

The Wiper Multi-Function Switch can control the front/rear wipers and washers. Proper use of the wiper and washer under various weather conditions can enhance the driver's visibility.



Operation

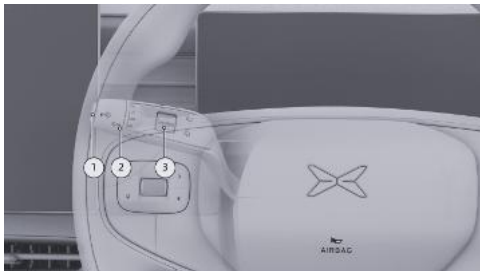

1. Washer switch

- Press: Wipe once.
- Press and hold: Front washer sprays water and front wiper works.

2. Front wiper switch

You can activate or deactivate the front wiper by turning the corresponding switch.

- OFF: Stop wiping.
- AUTO: Wipe based on the rainfall.

On the central control screen, go to “ → **Window & Door**” interface, and you can set the automatic wiper sensitivity.

- LO: Wipe at low speed.
- HI: Wipe at high speed.

3. Rear Wiper Switch

- Push up: The rear wiper operates/stops wiping.
- Short pull down: Activates one rear wiper cycle.
- Long pull down: The rear washer sprays while the rear wiper wipes.

i Tips

Operate the rear wiper switch and when released, the switch will return automatically.



caution

When washing with the rear wiper, when the switch is released, the rear wiper will continue to brush 3 times and once after 10s.

Warnings, Cautions and Limitations

caution

- Before operating the wiper stalk, ensure that the front compartment lid, boot, and main door are fully locked.
- When washing the vehicle, switch off the automatic wipers to avoid damage to the wipers or personal injury.
- When using the wipers in adverse weather conditions, make sure the blades are not frozen/stuck to the windshield.
- If there is snow, debris, etc. on the wipers or windscreen, remove before use, park the vehicle in a safe area and remove.

warning

- Automatic wipers are an auxiliary function and the driver still needs to manually adjust the wipers if necessary to keep driving safely.
- Do not dry wipe the wipers without water, if the rainfall is low, spray washer fluid before using the wipers to avoid damaging the windshield and wiper blades.

Gearshift Control

Introduction

Shift gears using the lever on the right of steering wheel.

Operation

caution

Please shift with the vehicle stationary.



Driving Operation



R: Reverse gear

Press the brake pedal and push the gearshift lever upward for two gears at the same time to shift to R position, in which case the backup light turns on.

N: Neutral

The vehicle can be shifted to N position by the following operations:

- With the vehicle in D position, press the brake pedal, and push the gearshift lever upward for one gear and hold it for 1s.

- With the vehicle in the R position, press the brake pedal, and push the gearshift lever downward for one gear and hold it for 1s.
- With the vehicle in P position, press the brake pedal, and push the gearshift lever upward or downward for one gear and hold it for 1s.

D: Drive

Press the brake pedal and push the gearshift lever downward for two gears to shift to D position.





"P" - Park:

Press the brake pedal, and press P-position switch on the gearshift lever to shift to P position.

- On the central control screen, go to “ → **Window & Door**” interface, and you can turn on or off the “**P Gear Shortcut**”. After shifting to P gear, you can see common control options in the lower right corner of the central control screen. In this way, one-touch operation is more convenient.
- After gear shifting, the corresponding gear indicator on the instrument will be black.
- The vehicle will shift to P position automatically when the driver's door is opened with the gearshift lever in D or R position at a speed less than 3 km/h, seat belts not fastened, and brake pedal and accelerator pedal not pressed.
- When the conditions for gear shifting are not met, the instrument will give a text prompt.

Please operate according to the prompt and shift gears after the conditions are met.

Warnings, Cautions and Limitations

Tips

With vehicle in D or R and vehicle speed less than 3 km/h, without seat belt, brake and accelerator pedals applied, Open the main drive door and the vehicle will automatically shift to P.

caution

- Before leaving the vehicle or on a ramp, make sure the vehicle is in P to prevent the vehicle from moving without cause.
- If you are unable to shift gears properly, you should contact the XPENG Automobile Service Center for service.



Braking Control

Introduction

The following features can be configured for brake operation:

- Brake pedal feel
- AUTO HOLD
- Comfortable Braking
- EPB

Operation

Brake pedal feel

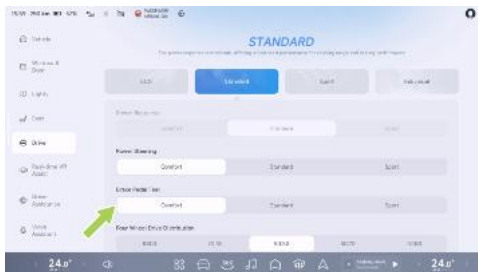

On the central control screen, go to “ → Drive” interface, and you can set “**Brake Pedal Feel**”.

Select an appropriate brake pedal feel according to personal preference.

- Comfort: The braking force response is smooth and the riding experience is more comfortable.



- Standard: The braking force response is moderate, and the driving pleasure and riding comfort are also ensured.

i Tips

Standard pedal force and pedal travel are suitable for most drivers.

- Sport: The braking force response is fast, and the driving control is more flexible.

AUTO HOLD

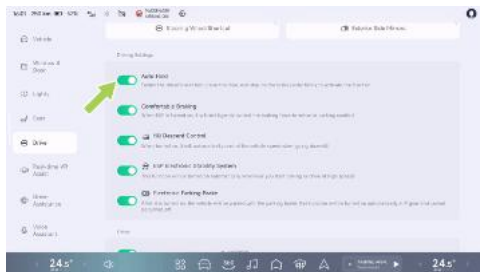

On the central control screen, go to “ → Drive” interface, and you can enable or disable “AutoHold”.

- If you need to stop the vehicle for a short time, you can activate AUTO HOLD and release the brake pedal. The system will apply brake automatically and keep the vehicle stationary.
- Function activation: After the vehicle stops, press the brake pedal hard, and the  indicator on the dashboard will illuminate to activate AUTO HOLD. At this time, release the brake pedal.

i Tips

Auto park is only active when the main door is closed, the seat belt is fastened and the gear is in D/R/N.

- Function deactivation: After AUTO HOLD is activated, press the accelerator pedal to deactivate AUTO HOLD.



i Tips

- When automatic parking is active, opening the primary door or unplugging the seat belt automatically switches to the EPB.
- After a period of automatic park hold, the switches to EPB.

⚠ caution

Automatic parking cannot override the dynamics, please turn on automatic parking according to the road conditions.

Comfortable Braking

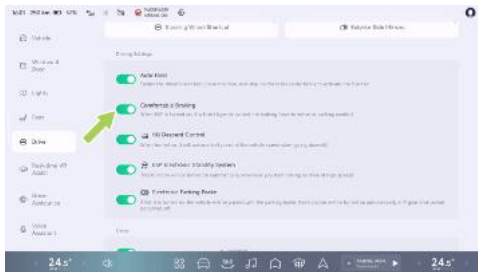

On the central control screen, go to “ → Drive” interface, and you can select to enable or disable “**Comfortable Braking**”.

- Once enabled, the system intelligently controls the brake force at the brake end, automatically and smoothly releasing brake pressure to enhance vehicle braking comfort and effectively reduce brake dive.



EPB

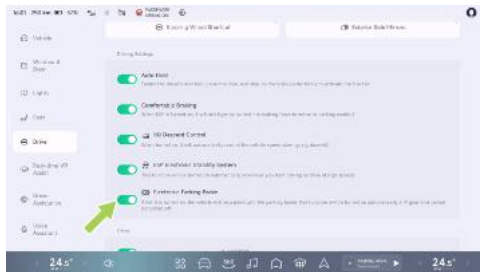

On the central control screen, go to “ → Drive” interface, and you can enable or disable the “**Electronic Parking Brake**” (EPB).

- When the vehicle is stationary, turn on “**Electronic Parking Brake**” or press the P position switch. The on the dashboard will illuminate, indicating that the EPB is activated successfully.
- When the vehicle is stationary, press brake pedal, press the brake pedal, shift to a non-P

gear, and turn off “**Electronic Parking Brake**”. At this moment, the on the dashboard goes out, indicating that the EPB is deactivated successfully.

Tips

- “”The EPB cannot be switched off by switching off the electric park brake when the vehicle is in P.
- It is normal for the system to make an operating noise when the EPB is on/off.
- In exceptional cases, a long press of the P switch activates the EPB emergency braking function.

caution

- If the vehicle does not operate/close the EPB correctly, contact your XPENG Vehicle Service Centre for service immediately.
- If the vehicle cannot be powered up due to a flat battery, the EPB cannot be switched off, this can be handled by closing after a



jump start or contacting XPENG Automobile Service Centre.

- Do not drive the vehicle without the EPB switched off, as it is highly susceptible to damage.

Cautions and Limitations

Driving Through Water

After driving through water, gently apply the brake to drain water and restore braking performance. Avoid emergency braking unless necessary.

Dynamic Driving

Under high-speed, continuous, and relatively urgent braking conditions, the brake disc temperature rises rapidly, causing braking efficiency to decline. To ensure safety, when the brake pads are severely worn and the temperature is excessively high, the Integrated Power Boost (IPB) system degrades. Multiple MILs illuminate on the dashboard, a 'clicking' sound emanates from the front cabin when

braking, and the brake pedal feels like it's kicking the foot. In such instances, it is necessary to reduce vehicle speed and minimize braking. Allow the brake disc and friction plate to cool, then perform a recovery operation.

The recovery operation steps are as follows:

1. Lock the vehicle and power it off. Wait for at least 5 minutes. During this time, avoid sitting in the driver's seat, stepping on the brake, opening doors, or operating the vehicle to ensure it enters a complete sleep mode.
2. Unlock and power on the vehicle. Wait at least 15 seconds before opening the door and entering the vehicle.
3. Fully press down the brake pedal with force (applying maximum pressure against the seat backrest) and hold for at least 20 seconds.

caution

The G6 braking system is non-track designed, if an individual user is driving hard or brushing the lap time on the track, the user is asked to



replace the high temperature pads and cool the discs when appropriate.

Driving Modes

Operation



On the central control screen, go to “ → Drive” interface, and you can select the driving mode according to your preferences.

- ECO: The power response is gradual, facilitating an extended driving range.

- Standard: Power response is moderate, balancing driving range and performance.
- Sport: The power response is swift, delivering exceptional driving pleasure.
- Individual: The user can adjust multiple parameters for personalized driving pleasure.
- Slip-Start Mode: The power response is smooth, providing maximum torque to enhance all-terrain performance.

Only in “**Sport**” mode, the “**Launch**” switch will be displayed.

Launch Mode is active only during the current Power Off cycle. If Launch is disabled or the vehicle is powered on again, Launch Mode will deactivate.

4WD System*

Introduction

This vehicle's drive system is Timely Four-wheel Drive. On the central control screen, go to



“ → Drive” interface. After selecting “**Four Wheel Drive Distribution**→**50:50**”, the system intelligently alternates between 2WD and 4WD modes according to the vehicle's operating conditions.

- When driving on relatively well-conditioned roads, the vehicle prioritizes 2WD mode to ensure comfort and economy. If the driver requires higher power, the system switches to 4WD mode.
- When the vehicle operates on slippery, muddy, icy, snowy, sandy, or complex outdoor roads, as well as during medium-to-high-speed accelerations and large dynamic turns, the Timely Four-wheel Drive system promptly engages. It ensures all wheels' traction through intelligent torque distribution, achieving optimal passability and safety while maintaining vehicle stability and comfort.

4WD Distribution



On the central control screen, go to “ → Drive” interface, five adjustment levels for torque distribution are available, namely: 100:0, 70:30, 50:50, 30:70, and 0:100 for front and rear drive, respectively. The driving experience varies depending on the torque distribution selected. Choosing a 50:50 front-to-rear drive balance is recommended. The system will intelligently switch between 2WD and 4WD modes based on the vehicle's operational conditions.



Regeneration

Introduction

When the vehicle coasts or brakes, the regeneration function can convert part of the kinetic energy into electric energy to charge the traction battery and increase the driving range.

Operation



On the central control screen, go to “ → Drive” interface, and you can set “**Regeneration**”.

Factors affecting regeneration

The amount of power supplied to the traction battery through regeneration depends on the following factors:

1. Current state of the traction battery.
 - Traction battery SOC.
 - Traction battery temperature.
2. The regeneration level selected.

Cautions and Limitations

Tips

- Different levels of energy recovery correspond to different driving experiences.
- If Energy Recovery Braking significantly reduces vehicle speed (for example, when driving on a steep slope), the brake light illuminates to alert the driver of the vehicle behind you that you are slowing down.
- Energy recovery is not possible when the battery charge is 100%; energy recovery



is reduced when the battery is in a high charge state.

i Tips

On long and downhill slopes, try to use point braking and stop mode or high energy recovery to avoid loss of braking effectiveness due to continuous braking.

! warning

The braking effect produced by energy recovery is not sufficient for safe driving and the driver should apply the brakes to the vehicle in a timely manner, as appropriate.

Power steering

Operation

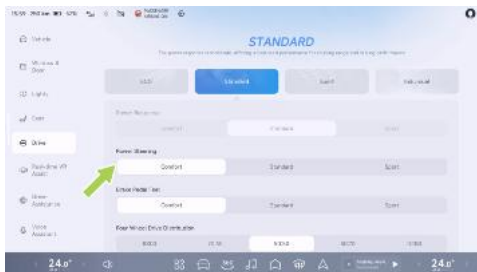

On the central control screen, go to “ → Drive” interface. Under “Power Steering”, you can select “**Comfort, Standard, or Sport**”.

- Comfort: The steering force is the minimum, and it is recommended for comfortable driving.
- Standard: The steering force is moderate, and it is recommended for general driving.



- Sport: The steering force is relatively heavy, and it is recommended for sport driving.

warning

- Do not adjust steering wheel position while driving vehicle.
- Improper steering wheel position adjustment can cause personal injury, at least 25 cm from the steering wheel to the driver's chest.

Use anti-skid chains

Introduction

When driving in severe environments such as snowy or icy roads in winter, tire chains can be used to increase tire friction and reduce sideslip. To use tire chains, the following suggestions must be followed:

- It is necessary to install tire chains when driving in deep snow. The vehicle is not equipped with tire chains, which can be purchased as needed. The size and type of

tire chains selected must conform to the tire specifications on the vehicle.

The dimensions and specifications of rims and tires suitable for installing tire chains are as follows:

Rim size	Tire specifications
18-inch rim	235/60 R18
20-inch rim	255/45 R20

- Install tire chains on the tire to ensure balanced driving in all kinds of weather. Keep in mind that the vehicle power may be insufficient after tire chains are installed. Drive carefully even if the road is in good condition. During driving, do not exceed the specified speed limit of tire chains or 50 km/h, whichever is smaller.
- Tire chains can only be installed on the rear wheels. Tire chains should be installed in pairs. Self-tensioning tire chains are not allowed.



- Do not use tire chains on dry ground. Remove tire chains once road surfaces are free from ice or snow.
- Install the tire chains as close to the tire as possible, and tighten them again after driving for 0.5-1.0 km.
- If the vehicle is equipped with wheel trim cover, remove it before installing tire chains.
- If you hear friction or crash sound between the tire chains and the vehicle during driving, stop the vehicle and re-tighten the tire chains. If this does not work, remove the tire chains to prevent damage to the vehicle.

Intelligent High Beam (IHB)

Introduction

The IHB can automatically switch between high and low beams according to the conditions of vehicles ahead and ambient lighting, to avoid affecting surrounding traffic participants.

Indicators on Dashboard



The IHB is enabled and the high beam is not on.



The IHB is enabled and the high beam is on.





The IHB has a fault.

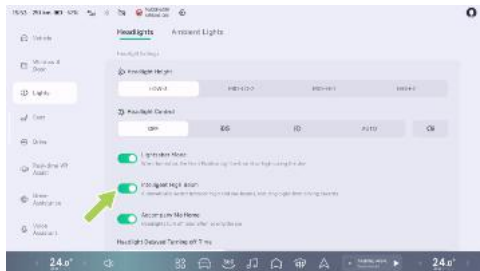

Operation

Opening and closing



On the central control screen, go to “ → **Lights** → **Headlights**” interface, and you can turn on /off “**Intelligent High Beam**”.

Use IHB

When the following conditions are met at the same time, the IHB is activated and the vehicle automatically switches between high beams and low beams according to the road environment:

1. The light switch of the central control screen is in automatic or low beam position.
2. The vehicle speed is greater than 30 km/h.

Tips

When IHB is active, the IHB will exit if the vehicle speed is less than 15 km/h.

Warnings, Cautions and Limitations

warning

The IHB may not function correctly in the following scenarios:

•

The above warnings, cautions, and limitations do not cover all conditions that may affect the normal operation of IHB.



Steering Wheel Position Adjustment

Introduction

Before driving, adjust the steering wheel's height and its distance from your body to ensure a comfortable grip and optimal driving posture.

Operation

Steering Wheel Position Adjustment



1. Adjust to a suitable driving position.

2. When the vehicle is stationary, pull down the steering wheel handle to unlock the steering wheel.
3. Move the steering wheel vertically and horizontally to a proper position.

caution

Make sure the instrument cluster screen and instrument indicator lamps are visible.

4. Pull the steering wheel handle upward to lock the steering wheel.

Tips

After adjusting the steering wheel position, try moving the steering wheel up and down, forward and backward to make sure the steering wheel is locked firmly in place.

Warnings, Cautions and Limitations

warning

- After adjusting the steering wheel position, verify that the steering wheel is locked,



injury or death may occur and property damage may occur.

- Do not adjust the steering wheel while driving.

Manually Anti-glare Interior Rearview Mirror

Introduction

Manually adjusting the anti-glare interior rearview mirror can minimize the reflection from lights behind, optimizing the rear view.



- When the tab is at the normal rear view angle, pulling it forward will deflect rear light reflections, achieving an anti-glare effect.
- Then pull the tab back to return to the normal rear view angle.

i Tips

It is recommended to use both hands when adjusting the interior mirror lens angle.



Operation

Adjust the angle of rearview mirror



1. Adjust the driver's seat to a suitable position.
2. Hold the interior rearview mirror and adjust its angle up and down, left and right, until you can properly view the rear of the vehicle through it.

Streaming Rearview Mirror*

Introduction

The Streaming Rearview Mirror can function as an ordinary mirror and a display screen. When switched to streaming media mode, the camera at the rear of the vehicle captures images of the area behind the vehicle for display, maintaining a good view even during daytime, nighttime, and in adverse weather conditions like rain, snow, and frost.



1. Rear photosensitive element



2. Streaming Rearview Mirror switch

caution

To ensure proper brightness adjustment:

- Do not obscure or cover the rear photoconductor unit.
- Keep the rear photoconductor unit clean.

Tips

Keep the rear view camera clean and dispose of any dirt.

Operation

Adjust the angle of rearview mirror



1. Adjust the driver's seat to a suitable position.
2. Hold the interior rearview mirror and adjust its angle up and down, left and right, until you can properly view the rear of the vehicle through it.

Tips

It is recommended to use both hands when adjusting the interior mirror lens angle.



Turn on or off Streaming Rearview Mirror

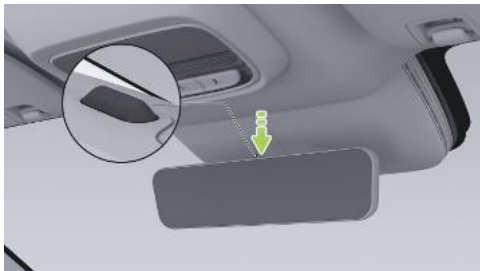

Press this button to switch from the streaming media mode to ordinary mirror mode. Press the button again to switch to streaming media mode.

- After each power-on, the Streaming Rearview Mirror will return to the status of the last memory.
- On the central control screen, you can also go to “ → Drive → Streaming Rearview Mirror” interface to enable or disable the Streaming Rearview Mirror feature.

- After switching to normal mirror mode, manually adjust the inner side mirrors angle to achieve an optimal rearview observation.

Central control screen setting interface



Open the Streaming Rearview Mirror adjustment interface by any of the following means:

- Xpeng voice.
- Bottom taskbar (if set) of the central control screen [See 38 page](#).



- On the central control screen, tap “ →**Drive**→**Streaming Rearview Mirror**”.

Turn on or off Streaming Rearview Mirror

On the central control screen, go to “ →**Drive**→**Streaming Rearview Mirror**” interface. After the Streaming Rearview Mirror function is turned on, switch it to streaming media mode. When this function is turned off, it switches to the normal mirror mode.

Field of view adjustment

The field of view is adjusted by altering the camera's capture angle to set the streaming rearview mirror's display angle to suit the driver's habits, thereby assisting the driver in observing the road conditions behind.

Manual visual field adjustment

On the central control screen, go to “ →**Drive**→**Streaming Rearview Mirror**” interface. Use the left scroll wheel to zoom in or out, and

the right scroll wheel to move the field of view up and down.

Automatic adjustment of view during reversing

On the central control screen, go to “ →**Drive**→**Streaming Rearview Mirror**” interface. If the automatic adjustment of the field of view during reversing is activated, the Streaming Rearview Mirror will automatically adjust the field of view when the vehicle is in the R gear. After the gear is shifted out of R, the view in the Streaming Rearview Mirror will restore to the pre-automatic adjustment setting.

Automatic adjustment of view at high speed

On the central control screen, go to “ →**Drive**→**Streaming Rearview Mirror**” interface. After the automatic field of view adjustment function for high speeds is activated, if the vehicle is in D gear and travels at speeds over 80 km/h for more than 10 seconds, the Streaming Rearview Mirror will automatically adjust the field of view. If the gearshift lever is switched to a non-D position or the vehicle speed remains at



or below 60 km/h for more than 10 seconds, the Streaming Rearview Mirror will restore to its pre-adjustment field of view under automatic vision adjustment.

Tips

When automatic field of view adjustment is on, the field of view position can still be adjusted manually.

Screen brightness regulation

On the central control screen, go to “ → Drive → Streaming Rearview Mirror” interface. Under “**Brightness Preference**”, you can select “**Lv.1, Lv.2, Lv.3, Lv.4, or Lv.5**”. At each brightness level, a certain range of automatic adjustment will be performed based on the ambient light.

Warnings, Cautions and Limitations

warning

- The streaming interior rear view mirror is an aid only and is not a substitute for the driver's judgment of the outside world.

Do not rely solely on the internal mirrors when driving or parking, in all circumstances the driver is responsible for the safety of the vehicle and is always aware of the surroundings.

- Do not install anything around the interior rear view mirror to prevent the driver from observing the road.
- Do not adjust the streaming interior mirror while the vehicle is in motion, as injury, death, and property damage may occur.

Do not use the streaming interior mirror in the following scenarios:

- Camera restricted
- Poor weather conditions (e.g. heavy rain, heavy snow, heavy fog, etc.).

caution

- In dark environments such as night time or tunnels, the rear light displayed on the display will have a certain amount of scattering and halo, creating a slight



obstruction to the field of view, requiring the driver to observe and drive with caution.

- When there are missing pixels in the streaming display, local or overall display is not normal, please switch to normal mirror mirror use and contact the XPENG Automobile Service Center in time for repair.
- Do not spray the camera when washing the vehicle with a high pressure water gun, as this may cause the system to malfunction due to water ingress into the camera.
- When the rear is damaged, the camera may not be able to obtain an accurate view, switching to the reflector is recommended.
- Check the internal mirror position before driving and adjust if necessary.



A/C

Page Display



1. PM2.5

- Tap the card to turn on or off air purification.
- It displays the air quality outside the vehicle.

2. Front/rear A/C switching

- Tap “**Front/Rear**”, and you can switch to the Front/Rear A/C Settings interface.

- It indicates the front or rear A/C ON status.
3. Driver's seat A/C components
 - It indicates the current temperature and air volume of the driver's seat A/C.
 - Adjust the driver's seat A/C.
 4. Adjust the temperature of driver's seat
 5. A/C mode
 - Tap “**SYNC**” to turn on or off the synchronous adjustment of the driver's seat temperature and the front passenger's seat temperature.

i Tips

Temperature synchronization is switched on automatically when the energy saving mode is selected.

- A/C: Turn on the rear air-conditioning cooling or heating.
- AUTO: After it is turned on, the A/C will automatically control according to the set temperature.



6. Blowing mode

- : Blow window.
- : Blow face.
- : Blow foot.

Tips

- A red wind indicates that the set temperature is higher than the inside temperature and the air conditioning is heating up.
- The blue wind indicates that the set temperature is below the in-vehicle temperature and the air conditioning is cooling.
- The off-white wind indicates that the set temperature is close to the interior temperature and the air conditioning is maintaining the temperature.

7. Turn on or off the front A/C

Tips

It is not recommended to switch on the air conditioning system during charging.

8. Adjust the air volume

9. Heating and defrosting or recirculation and fresh air

- : Turn on or off front windshield defrosting.
- : Turn on or off the rear windshield heater for defrosting and side mirror heater for defrosting.

Tips

During the heating process, if the 12V battery voltage is less than 9V, the heating is automatically switched off.

caution

- Do not use the heated defrost function for extended periods of time when the vehicle is not started, to avoid the 12V



Comfort Configuration

battery being discharged from starting the vehicle.

- Do not touch with your hands when the heated defrost function is on.

- : Switch between recirculation and fresh air.

10. Rapid temperature control or intelligent A/C

- Rapid Cooling: When activated, the A/C's temperature will be set to the lowest level, the airflow to the highest level, and the seat ventilation function will be enabled automatically.
- Rapid Heating: When activated, the A/C's temperature will be set to the highest level, the airflow to a high level, and the seat heating and steering wheel heating functions will be enabled automatically.

Tips

For added comfort, it is recommended to switch the air conditioning on remotely via the mobile app during summer (hot

or winter (cold) to cool/warm at extreme speeds.

- : Intelligent mode.

11. Adjust the front passenger's seat temperature

12. Front passenger's seat A/C components

- It indicates the current temperature and air volume of the front passenger's seat A/C.
- Adjust the front passenger's seat A/C.

A/C Mode

In the lower right corner of the A/C Setting interface, tap “ ” to select different intelligent A/C modes according to the situation.



1. Refresh

- Quickly remove the odor in the vehicle with efficient ventilation.

2. Energy-saving mode

- A/C can run in a more power-saving mode to reduce energy consumption and extend the endurance mileage.

i Tips

The cooling or heating effect of the air conditioning will be affected when switched on.

3. Intelligent cleaning

- After the vehicle is unlocked, it can intelligently detect water accumulation in the A/C system and enable the smart cleaning function to reduce bacteria breeding and reduce the probability of odor in the vehicle.

i Tips

It requires a certain amount of power to be consumed when turned on, with a small impact on battery life.

Air Purification

The air purification function determines exterior air quality via sensors and network, displaying the data on the A/C interface.



Comfort Configuration

The air purification can be turned on in the following ways:

- Say to Xpeng: air purification.

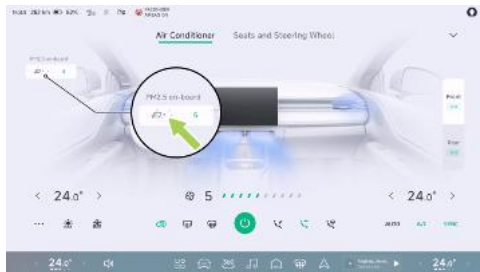

- Tap the area below PM2.5 on central control screen to start purification.

You can exit air purification in any of the following ways:

- During purification, tap the air purification icon in the upper left corner of the A/C control interface again to stop purifying.

- During air purification, turn off the A/C and turn on the front defroster to exit purification.
- During air purification, turn on rapid heating, rapid cooling and refresh to exit purification.

Page Display





1. PM2.5
 - Click the card to turn air purification on/off.
 - Displays the air quality outside the vehicle.
2. Front/rear air conditioning switch



- Click **“Front/Back”** the front/rear air conditioning setting interface can be switched.
 - Displays the front/rear air conditioning on status.
3. Driver air conditioning components
- Displays the current temperature and air volume status of the main driver's air conditioner.
 - Adjust the main driver's air conditioning.
4. Adjust the main driving temperature
5. Air conditioning mode
- Click **“SYNC”** Open/close the driver's seat temperature and the co-driver's seat temperature to adjust synchronously.
- When energy saving mode is selected, temperature synchronization is automatically turned on.
- A/C: Turn on the air conditioner to cool or heat.

- AUTO: After turning on, the air conditioner is automatically controlled according to the set temperature.

6. Blowing mode

- : Blowing windows.
- : Blowing face.
- : Blow feet.

Red wind means the set temperature is higher than the temperature inside the car and the air conditioner is heating.

Blue wind means the set temperature is lower than the temperature inside the car and the air conditioner is cooling.

Gray-white wind means the set temperature is close to the temperature inside the car and the air conditioner is maintaining temperature.

7. Turn on/off the front air conditioner

It is recommended not to turn on the air conditioning system during charging.

8. Adjust air volume



Comfort Configuration

9. Heating defrost/internal and external circulation

- : Turn on/off the windshield defrost.
- : Turn on/off rear windshield heating and defrosting, exterior mirror heating and defrosting.

Tips

During the heating process, if the 12V battery voltage is lower than 9V, the system will automatically turn off the heating function.

caution

- When the vehicle is not started, it is forbidden to use the heating and defrosting function for a long time to avoid the 12V battery running out of power and being unable to start the vehicle.

- When the heating and defrosting function is turned on, do not touch it with your hands.

- : Switch between internal and external circulation.

10. Ultra-fast temperature control/intelligent air conditioning

- Ultra-fast cooling: When turned on, the air conditioning temperature will be adjusted to the lowest, the air volume will be adjusted to a high level, and the seat ventilation function will be automatically turned on.
- Ultra-fast heating: When turned on, the air conditioning temperature will be adjusted to the highest level, the air volume will be adjusted to a high level, and the seat heating and steering wheel heating functions will be automatically turned on.



i Tips

To enhance the comfort experience, it is recommended to remotely turn on the air conditioner through the mobile phone app for rapid cooling/heating in summer (high temperature) or winter (low temperature).

- **⋮**: Intelligent mode.
11. Adjust passenger temperature
 12. Passenger air conditioning components
 - Displays the current temperature and air volume status of the passenger side air conditioner.
 - Adjust the passenger side air conditioning.

Air Vent Adjustment

The air vents in the front and rear can be manually adjusted.

Adjust front row side air vent

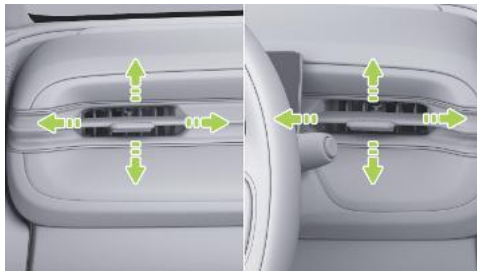

The wind direction of the air vent can be adjusted by turning it up, down, left, or right, and the air vent can be closed by turning it to the left/right.



Comfort Configuration

Adjustment of the front air vent of the console

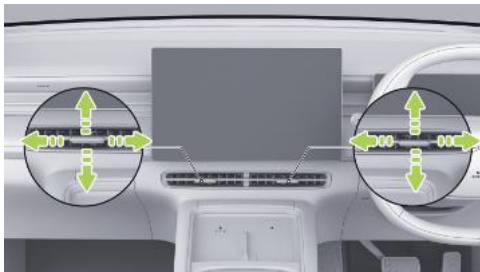

The wind direction of the air vent can be adjusted by turning it up, down, left, or right, and the air vent can be closed by turning it to the left/right.

Adjustment of the rear air vent



The wind direction of the air vent can be adjusted by turning it up, down, left, or right, and the air vent can be closed by turning it to the left/right.



Steering Wheel

Steering Wheel Key



1. Left and right buttons:

- Default: Adjust the A/C blower speed.
- With the ACC/LCC activated, adjust the cruise distance.
- After activating the side mirror adjustment, control the left side mirror to turn leftward or rightward.

2. Upper and lower scroll buttons:

- Roll up and down to adjust the A/C temperature.
 - Tap and hold it to enter the card switching mode on the left screen of the dashboard, scroll up or down to select cards, and tap to confirm what you choose.
 - When ACC/LCC is activated, scroll up or down to adjust the vehicle's speed incrementally.
 - After activating the side mirror adjustment, roll up and down to turn over the left side mirror.
 - On the Streaming Rearview Mirror* adjustment interface, scroll up and down to zoom in or out of the field of view of the Streaming Rearview Mirror.
- #### 3. Steering wheel shortcut key:
- Tap and hold this key to set the function of it, and tap it to execute the set function.
- #### 4. Voice wake-up button:
- Wake up or cancel Xpeng voice.



Comfort Configuration

5. Previous or next song button:

- Tap to play the previous or next radio station, chapter, or song.
- After activating the adjustment of side mirror, control the right side mirror to turn leftward or rightward.

6. Upper and lower scroll buttons:

- Scroll up and down to adjust the media volume.
- Tap the multimedia play, pause, or pop-up window to confirm.
- Tap and hold it to enter the card selection status on the right side of the instrument cluster.
- When there is a phone call, scroll up/down to select Answer/Reject, and tap the scroll wheel to confirm. During the call, tap it to hang up.
- After activating the side mirror adjustment, roll up and down to turn over the right side mirror.

- On the Streaming Rearview Mirror* adjustment interface, scroll up and down to adjust the upper and lower positions of the field of view of the Streaming Rearview Mirror.

7. Mute button: tap to mute or unmute.

8. Return key.

Horn



Tap the horn mark area to sound the horn.



caution

Do not press the horn identification area for long periods of time, as this can cause damage to the horn.

Key emergency function

Tap and hold the voice wake-up button and mute button at the same time to restart the dashboard and central control screen.

This function can be temporarily used in cases such as abnormal display of the dashboard or central control screen and sudden screen jamming. If the fault still exists after restart, please contact XPENG Service Center for maintenance in time.

Steering wheel shortcut key

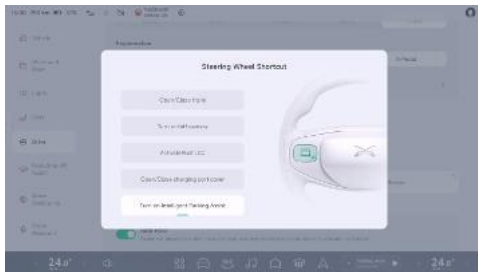

Tap and hold the steering wheel shortcut key or go to “ → **Drive** → **Steering Wheel Shortcut**” interface on the central control screen. You can set the steering wheel shortcut key function.

Steering Wheel Heating

You can control the steering wheel heating in the following ways:

- Mobile App key
- Xpeng voice



- Central control screen
 - Bottom taskbar (if set)
 - Setting interface

Central control screen setting interface

On the A/C Settings interface [See 263 page](#), tap **“Seats and Steering Wheel”** to enter the settings interface.



Tap “” to turn on the steering wheel heating function. The default is Level 3. Repeatedly tap it in the cycle of Level 2, Level 1, OFF, and Level 3.

Window

Introduction

The windows can be opened or closed by the following ways:

- Window switch
 - Driver's seat side window switch
 - Passenger side window switch
- Mobile App key [See 200 page](#)
- Xpeng voice
- Central control screen setting interface

i Tips

- Do not switch the window repeatedly within a short period of time, as this will trigger the window thermal protection, the window lift function will fail after thermal protection, wait approximately 2 minutes before operating.
- When the window is closed, if an obstacle is encountered in the anti-trap area, the



window will stop closing and reverse for a distance.

- If the window is closed with one touch and the anti-trap function is disabled, the window initialization can be performed.

warning

- To ensure safety when children are in the vehicle, lock the passenger glass up and down to prevent children from operating the windows to avoid pinching.
- Even if the windows are equipped with anti-trap, there is still a risk of pinching when closing the windows, do not use any part of your body to block the windows from closing to activate the anti-trap.
- Before closing the windows, the driver must ensure that all passengers, especially children, do not protrude any part of their body out of the window, otherwise there is a risk of pinching!
- When the automatic window locking feature is switched on, the windows will close

automatically when the vehicle is locked, make sure that the windows do not jam occupants or obstructions and that there are no occupants in the vehicle, especially children. Then lock.

- Make sure the vehicle is powered down before leaving the vehicle.

Operation

Driver's seat side window switch



1. Front left door window regulator switch



Comfort Configuration

2. Front right door window regulator switch
3. Locking switch of passenger door glass regulator
4. Rear right door window regulator switch
5. Rear left door window regulator switch

Passenger side window switch



Pull the window regulator switch up/down to the second gear, and the window will automatically move to the fully closed/open position.

Pull the window regulator switch up/down to the first gear and hold it at this position, and then the window starts to rise/fall. Release the switch, and then the window stops moving.

When the passenger window switch disabling function is turned on, the indicator on the switch illuminates. At this time, the window switches on other doors are disabled, and all windows can only be adjusted by the window switch on the driver's door.

Central control screen setting interface





On the central control screen, go to “ → **Window & Door** → **Window Adjustment**” interface, and you can set “**Open All, Ventilate, or Close All**”. You can also swipe up and down in the window area for adjustment.

Tips

When the window locks are open, the window switches on the other doors are disabled and all windows can only be adjusted from the master drive side window switches.

Window lock

On the central control screen, go to “ → **Window & Door** → **Baby-in-Car Mode**” interface, and you can turn on or off the window lock.

Automatic window closing

On the central control screen, go to “ → **Window & Door**” interface, and you can turn on or off the “**Close Windows Automatically after Vehicle Locking**” and “**Close Windows**

Automatically when Traveling at High Speeds” functions.

Tips

It is recommended to switch on the external cycle mode when the window is automatically closed on high speed driving and when driving at high speed.

Window initialization

Window initialization can be performed if the window function is abnormal (such as failure of one-key up or down, and central control screen and voice adjustment):

1. Power on the vehicle and close the door. Gently pull the window switch to the first gear position (manual upward mode), fully close all windows and hold for 3 seconds, then release.
2. Firmly press the window switch to the second gear position and release it (automatic downward mode). The window will automatically lower to the open all position and stop.



3. Firmly pull the window switch up to the second gear position (automatic upward mode), and it will stop after reaching the fully closed position.

The following steps can determine whether initialization learning has completed. If all steps function normally, the initialization is successful:

1. Following the procedure in step two above, verify whether the window can automatically lower to the fully open position.
2. Following the procedure in step three above, verify whether the window can automatically rise to the fully closed position.

caution

- The process of setting global opening and closing takes less than 15 seconds.
- Setting the global opening and closing must be completed in succession, only one of these steps may cause the anti-trap function to fail and require two consecutive steps to avoid this risk.

Sun Visor and Vanity Mirror

Introduction

Sun visor



Sun visor can be flipped down in the direction of arrow to block sunlight coming in through front windshield.



After flipping down the sun visor, take out one end of the sun visor, which is close to the interior rearview mirror, from the bracket and turn the sun visor over towards the window to block sunlight coming in through the window.

⚠ warning

A tilted sun visor may affect the forward view, if it is no longer necessary to use the sun visor, it must be retracted into the bracket.

Vanity mirror



The sun visors at both the driver's and front passenger's sides are equipped with vanity mirrors, allowing you to freshen up your appearance.

- You can unfold the sun visor to a suitable position, lower the vanity mirror cover plate (which can also be magnetically attached to the back of the sun visor), and turn on the vanity mirror light.



- After the vanity mirror cover plate is closed, the vanity mirror light will go out and then you can fold the sun visor.

i Tips

- Close the vanity mirror cover when not in use.
- If the vanity mirror cover has been magnetized to the back of the visor, when the vanity mirror is not in use, adjust the visor to the non-use position to switch off the vanity mirror lamp.

! warning

Do not use the vanity mirror while driving the vehicle.

Panoramic Sunroof

Introduction

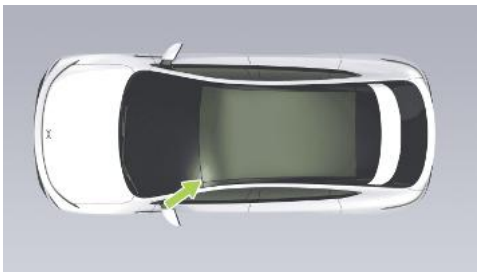

The vehicle is equipped with a panoramic sunroof, offering a wider view and a heat-insulating coating to enhance your driving experience.

! caution

The panoramic roof temperature rises after the vehicle has been exposed to the sun, do not touch it, as there is a risk of burns.



Reading light

Introduction

You can turn on or off the reading light by the following means:

- Reading light switch
- Central control screen
 - Setting interface
- Xpeng voice

i Tips

The reading light automatically illuminates when the door is opened, and the reading light automatically extinguishes when the door is closed.

⚠ warning

Do not switch on the front reading lamps while driving with low ambient light, the front windscreen may reflect, resulting in a safety incident where the road ahead is not visible.

Operation

Reading light switch

Front reading light



The reading light is installed in the front dome light assembly. It will turn on by touching the lightshade, and turn off by touching the lightshade again.

Rear reading light



Press the corresponding reading light button on either side to turn on the reading light, and press again to turn it off.

Central control screen setting interface

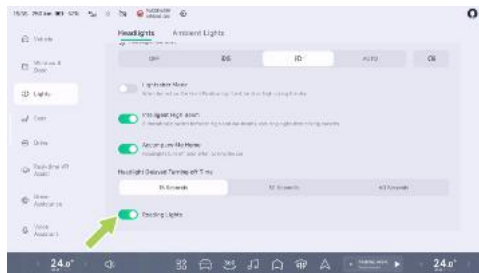

On the central control screen, go to “ → **Lights** → **Headlights**” interface, and you can turn on or off “**Reading Lights**”.

Ambient Lights

Introduction

The vehicle is equipped with ambient lights that can change color in sync with the music rhythm,



adding a warm touch to your drive home as night falls.

Opening and closing



On the central control screen, go to “ → **Lights** → **Ambient Lights**” interface, and you can set the ambient lights.

Brightness adjustment and color selection

Once the ambient lights are on, you can adjust their brightness manually. Ambient light colors are available in fixed single and two-tone options depending on the mode.

Ambient light mode

Ambient lights offer four mode settings: Fixed Brightness, Smooth Breathing, Follows Speed, and Music Rhythm. You can choose what you like on the Ambient Lights control interface.

Seat Heating*

Introduction

You can control the seat heating by the following means:

- Mobile App key [See 77 page](#)
- Xpeng voice
- Central control screen
 - Bottom taskbar (if set) [See 38 page](#)

i Tips

The bottom task bar only supports controlling the heating of the master/passenger seat.

- Setting interface



Operation

Central control screen setting interface

On the A/C Settings interface [See 263 page](#), tap “**Seats and Steering Wheel**” to enter the settings interface.



Tap “” to activate the heating function of the corresponding seat. When it is set at Level 3, you can repeatedly tap it in a cycle of Level 2, Level 1, Off, and Level 3.

warning

- Do not use the seat heating function if the person in contact with the seat does not feel pain, as personal injury may result.
- Extended use of a high-speed heated seat can cause cold burns.
- Using the host seat heating for extended periods of time may cause distress and affect safety.

Seat Ventilation

Introduction

You can control the seat ventilation by the following means:

- Mobile App key [See 77 page](#)
- Xpeng voice
- Central control screen
 - Bottom taskbar (if set) [See 38 page](#)
 - Setting interface



Operation

Central control screen setting interface

On the A/C Settings interface [See 263 page](#), tap “**Seats and Steering Wheel**” to enter the settings interface



Tap “” to activate the ventilating function of the corresponding seat. When it is set at Level 3, you can repeatedly tap it in a cycle of Level 2, Level 1, Off, and Level 3.

Seat Massage*

Introduction

You can control the seat massage by the following means:

- Xpeng voice
- Central control screen

Operation

Central control screen setting interface

On the central control screen, go to “ → **Seat→Massage**” interface, and you can set the seat massage function.



Comfort Configuration



1. Tap “” to select the seat to be adjusted.
2. Tap to enable or disable the driver message feature.
3. You can choose the massage mode according to your preference, and tap to enable the seat massage function.

Tips

The different massage modes correspond to the duration of the massage and when the time is reached, the seat massage is automatically switched off.

4. Tap to select the massage intensity.
5. Tap to enable or disable the driver's lumbar pressure relief feature.
6. Tap to select the lumbar pressure relief mode.

Tips

- The Main Drive Massage and Lumbar Soothing can only be switched on separately, switching Lumbar Soothing on automatically switches the massage off when the massage is active and switching the massage on automatically turns the Lumbar Soothing off when the massage is active.
- Manual lumbar adjustment interrupts lumbar soothing mode when Lumbar soothing mode is active.



Driver's audio

Operation

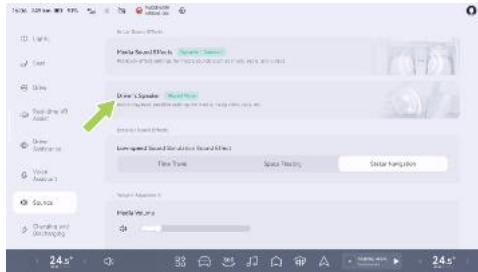

On the central control screen, go to “ → **Sounds** → **Driver's Speaker**” interface, and you can set the driver sound mode.

The driver's seat audio system features three modes:

- **Shared Mode:** Navigation, call, and media sounds are played through the entire vehicle's audio system.

- **Driving Mode:** Navigation and call sounds are played through the driver's headrest audio, while media sounds are played via the entire vehicle's audio system.
- **Private Mode:** Navigation, call, and media sounds are played through the driver's headrest audio system.

Tap “**Intelligent Switch**”. The vehicle will automatically shift to “**Driving Mode**” when the front passenger's seat is occupied.



Wireless Charging

Introduction

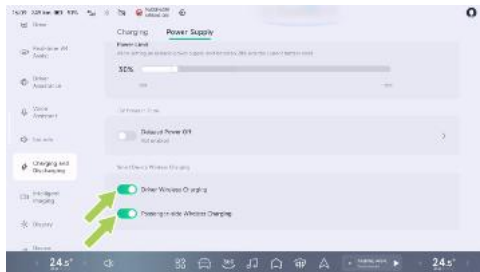

On the central control screen, go to “ → **Charging and Discharging** → **Power Supply**” interface, and you can enable or disable wireless charging for the driver and front passenger.

caution

Some mobile phones do not have wireless charging function, the mobile phone placed on the wireless charging panel may cause the

screen to flash, bounce, etc., if necessary, It is recommended that the wireless charge switch is turned off in the central control screen.



The wireless charging area is located in the front of the console. During charging, please face the mobile phone screen upward and slide the mobile phone to the bottom of the charging area along the limit bar, which is conducive to inductive charging and heat dissipation of the mobile phone. During charging, the “” icon will be displayed on the central control screen.



- Mobile phones support a maximum wireless charging power of 50W, and have the air cooling capability. You can cool the phone through air cooling to improve charging efficiency.
- On the central control screen, go to “ → **General** → **Safety and Privacy**” interface, and you can enable or disable “**Cell Phone Left Behind Reminder**”. Once this function is enabled, if the mobile phone is wirelessly charging, a reminder will be triggered when you are getting out of the vehicle.

Wireless charging will cease in the following Combos:

- When the mobile phone is placed at the top of the charging area, there may be charging or induction failure.
- Charging will stop when the vehicle starts searching for the key.
- The driver's door is unlocked, the four doors are closed, and the trunk is closed.

warning

- To avoid interference between medical or implantable electronic devices and the wireless charging system for mobile phones, personnel using medical or implantable electronic devices should maintain an appropriate distance from the wireless charging area of the mobile phone.
- The wireless charging function of mobile phones can heat metal. Please ensure that there are no metal foreign objects on the back of the phone and in the charging area before starting charging. Otherwise, the metal foreign objects may be heated or damaged, and even cause safety accidents. The metal foreign matter here refers to other objects with metal components, including but not limited to chips, magnetic cards, etc.
- For phones that do not have wireless charging, it is recommended to manually tap the center screen setting to turn off wireless charging in the corresponding area to avoid affecting the normal use of the phone.



Comfort Configuration

- For mobile phones with 50W power wireless fast charging, the phone must be placed along the limit bar at the bottom of the charging area, and the bottom of the phone should be fully covered to avoid overheating problems.
 - The wireless charging cooling fan outlet is located at the lower end of the wireless charging, be aware that foreign objects and liquids enter the outlet and affect the operation of the fan.
 - Do not spill water on the wireless charging area to prevent water from entering the wireless charging module and damaging the electronic components.
 - External wireless charging coils can cause accidents and should be used with caution.
 - When the driver is not in the car, please do not place the mobile phone in the car to charge, so as to avoid safety hazards
 - Please do not place heavy objects in the charging area to avoid damaging the wireless charging module.
- If the wireless charging function does not work or does not work properly, stop using it and contact the XPENG Automobile Service Center for service.
 - It is normal for the phone to get warm after a long charge. Do not leave the charging device in the charging area after it is fully charged, as this may cause overheating problems.
 - Do not use a metal phone case, such as one that supports magnetic charging (MagSafe).



Charging and Data Ports

Introduction

Front port of central armrest box



1. USB media source port: used for data transmission of driving video USB drive, microphone, game controller, etc.
2. Type-C power port: used for data transmission of driving video USB drive and charging of electronic devices, supporting standard charging protocol, with a maximum power output of 60W.

3. 12V power port: It has the maximum power of 180 W.

caution

Charging using the USB media source connection is prohibited, charging may cause the central control screen to restart or the screen to go blank.

Rear port of central armrest box



1. The Type-C power port supports a maximum power of 15W.



warning

Private modification of the Type-C interface is prohibited.

Internal port of trunk

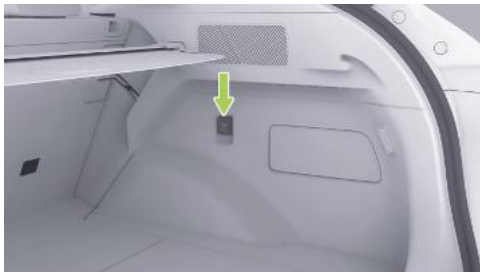

12V power port: It has the maximum power of 180 W.

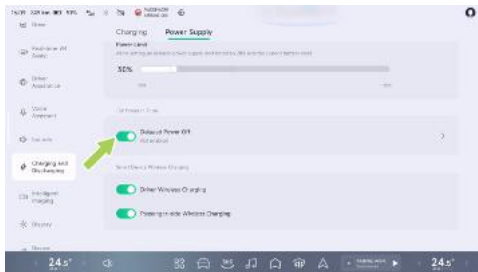

On the central control screen, go to “ → **Charging and Discharging** → **Power Supply**” interface, and turn on “**Delayed Power Off**”. You can set the delayed power-off time of the trunk 12V power supply after the vehicle is powered off.



Trunk Cargo shade

Use of Cargo Shade

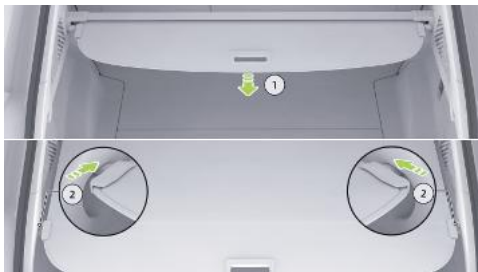

1. Pull out the cargo shade.
2. Insert both ends of the cargo shade into the fixing grooves on each side of the trunk.

warning

Do not place any objects on the blind when it is deployed, as this will damage the blind or cause injury to the occupants of the vehicle in the event of a collision.

Removal and Installation of Cargo Shade

- Fold the rear seat backrest.
- Retract either end of the cargo shade and remove it.
- To install, first secure one end of the cargo shade into the fixing groove, retract the other end, and then lock it into place.



Storage Space

Introduction

Center Armrest Switch



The auxiliary instrument is equipped with a central armrest box, which can be opened and used by pressing the switch.

Door storage box



The car door is equipped with a storage box for drinks or other items.

Comfort Configuration



Front Cup Holder

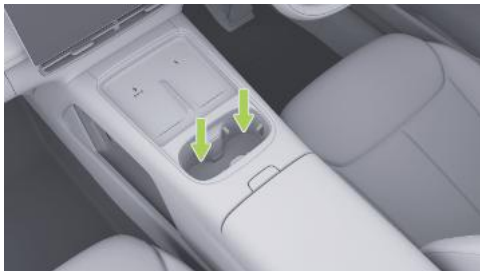

There is a cup holder on the auxiliary instrument panel, which can be used to place drinks or water cups.

Rear Cup Holder



After folding down the center armrest of the rear seat, lightly press the front of the armrest to open the cup holder for use.

 **caution**

When using the cup holder, avoid placing small items and other debris to prevent the cup holder from getting stuck.



warning

When the vehicle is moving, do not place open beverages or water cups on the cup holder to prevent the hot drink in the cup from splashing out and scalding the driver and passengers in the vehicle, or damaging the vehicle and its electrical equipment.

Map pocket



There are map pockets under the backrests of the front seats, which can store tickets, magazines and other items.

Trunk



The trunk storage space can be used to store luggage and cargo.

caution

- Do not store fragile, flammable, explosive and other dangerous goods in the trunk to avoid fire, explosion or damage to items
- When storing liquid items, pay attention to the sealing to avoid damage to the vehicle due to liquid leakage. If leakage occurs, please clean it up in time.



- Do not drive the vehicle when it is overloaded to avoid excessive braking distance due to excessive inertia, which may cause accidents.

caution

- Check the roof rack regularly to make sure it is securely installed and not damaged.
- When the rack is not installed, make sure the cover is closed over the interface.

Introduction

Central armrest box



The console is equipped with a central armrest box, which can be opened by pressing the switch.



Comfort Configuration

Door storage box



The door features a storage compartment suitable for holding beverages or organizing items.

Front-row cup holder

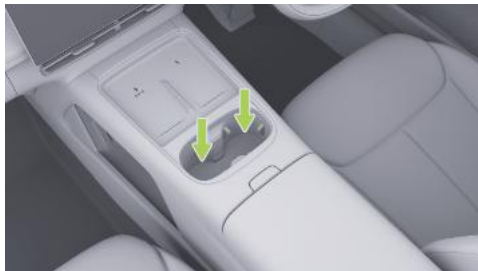

The console is equipped with a cup holder to hold drink bottles or cups.



Rear Cup Holder



After tilting down the central armrest of the rear seat, press gently on its front section to reveal the cup holder.

caution

Avoid placing small pieces and other debris when using the cup holder to prevent it from sticking.

warning

Do not place open drinks or cups on the cup holder while the vehicle is in motion. To avoid scalding the driver and occupants of the vehicle, or damaging the vehicle and the interior electrical equipment from a hot drink in the cup.

Map pocket



Map pockets are provided on the back of front seats for storing articles such as bills and magazines.



Trunk



The trunk can be used to place luggage and goods.

caution

- Do not store fragile, flammable, explosive, etc. in the loadspace to avoid fire, explosion, or damage.
- Store liquid items with a tight seal to avoid damage to the vehicle due to fluid leaks. Clean up if leakage occurs.

- Do not drive the vehicle with an overloaded vehicle to avoid excessive braking distances due to excessive inertia, which could result in an accident.

Luggage Rack Interface

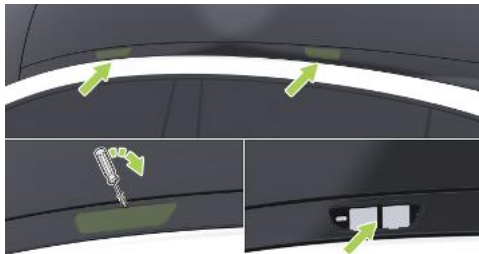

The roof luggage rack interface on this vehicle supports the installation of a load-bearing roof rack, with a maximum load capacity of 75kg.

Before installing or using the roof rack, please thoroughly review this chapter and the



instructions provided for the roof rack, and adhere to all related safety warnings.

caution

- The roof rails need to be checked regularly to ensure they are securely fitted and free from damage.
- When the luggage rack is not fitted, make sure the lid is closed to the interface.

Trailer Mode*

Introduction

Your vehicle is equipped with the function of towing a motorhome, which can only be utilized after activating Trailer Mode on the Central Control Screen. When towing a motorhome, the driver must possess the necessary driving qualifications.

Before deciding to tow a motorhome, you should first review the motor vehicle regulations in your region. As regulations differ across regions, it

is essential to select an appropriately specified RV and consult a local service provider prior to towing.

caution

- When towing a motorhome, please observe the local laws and regulations and do not allow for private modifications.
- Do not tow the caravan during the break-in period of the new vehicle.
- Stow the towing device when the caravan is not towed.
- It is not allowed to tow an RV equipped with an electric service brake system.

Driving Instructions

Towing a trailer can impact the handling and braking performance of your vehicle. To ensure safe trailer towing and protect the safety of you and your passengers, follow these driving recommendations:



Comfort Configuration

- Accelerate gradually and avoid sudden acceleration or emergency braking. On slippery road surfaces, such actions could cause the vehicle to lose control due to skidding. Crosswinds and uneven roads can cause vehicle swaying, significantly impairing vehicular control. In any case, as long as you notice a slight sign of vehicle swaying, hold the steering wheel tightly with both hands and immediately reduce the speed slowly. Do not try to eliminate the sway by increasing the speed.
- Attempt to avoid Combos where the towing vehicle is unloaded while the trailer is loaded. If unavoidable due to an unbalanced load distribution, reduce your driving speed.
- When towing a trailer, the braking distance of the vehicle increases. Therefore, increase the driving distance from the vehicle ahead.

Indicators on Dashboard



The trailer wiring harness is functioning normally, as are the

Suspension, Electronic Stability Program, and Trailer Hook systems.

The trailer wiring harness functions normally; however, faults in the Suspension, Electronic Stability Program, or Trailer Hook may prevent the trailer mode from operating properly.

Trailer mode is unavailable due to faults in the trailer wiring harness, trailer signal lamp, Suspension, Electronic Stability Program, and Trailer Hook.





Opening and Closing

On

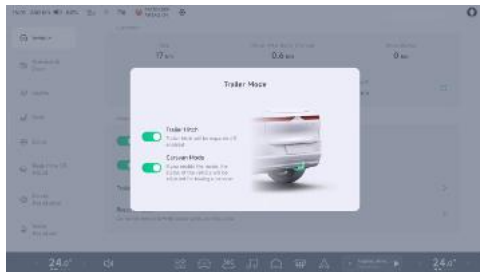

When the vehicle is in P gear, on the central control screen, go to “→Vehicle” interface, and you can turn on or off “**Trailer Mode**”.

caution

- A second confirmation is required when both the towbar and trailer modes are switched on and must be performed in P gear.

- The central screen switch is not available during towbar movement and is returned to service when fully extended or retracted.
- When the towbar is switched on, none of the driving aids, except AEB, FCW functions, can be switched on. When the towbar is fully closed, driving aid related functions revert to the pre-towbar open state.

Trailer mode will not turn on when:

- The vehicle is in non-P gear.
- The towbar does not open.
- Suspension fault, ESP function fault.
- When the suspension is in service mode and the suspension leveling mode is on.
- When calibrating the sensor after sales, lock-up mode.
- When the lift mode or sea transport mode is on.



caution

Towing mode must be switched on when towing, otherwise damage to the vehicle may occur.

OFF

After disconnecting the RV from the trailer hook and unplugging the electrical connector, press the trailer hook switch on the Central Control Screen to simultaneously exit Trailer Mode and retract the trailer hook.

Electrical Connection Connector



The electrical connector is mounted on the towing hook. After enabling the towing hook switch on the central control screen, the connector extends out along with the towing hook. After opening the protective cover, it is ready for use.

caution

Do not use a high-pressure water gun to wash the electrical connection directly when the electrical connection connector is not

Comfort Configuration



connected to the trailer coupling, as water ingress to the connection may result in damage.



The electrical connection connector equipped on this vehicle is a 13-core coil. The power outlet complies with the ISO 11446:2004 standard. The specific pin functions are as follows:

Pin number	Color	Function
------------	-------	----------

1	Yellow wire	Left turn signals
2	BU Wire	Rear fog light or reversing lights
3	WH wire	1-8 pin main ground wire
4	GN wire	Right turn signals
5	BN wire	Right running lights
6	RD wire	Brake lights
7	BK wire	Left running light (can be combined with Pin 5)
8	PK wire	Reversing lights
9	OG wire	To battery
10	GY wire	Battery or refrigerator
11	BK and WH wires	10-pin ground wire



12	Blue and white line	Standby wire
13	Red and white line	9-pin ground wire

Rearview Mirror and Bracket

The side mirrors of the tractor should comply with regulatory standards. If not adequate, install appropriate trailer side mirrors.

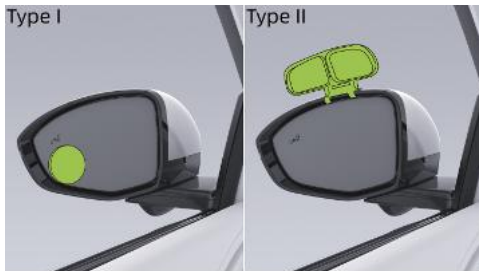

Type I

Adhere to the surface of the side mirrors.

Type II

Attach the bracket clip to the frame securely.

Technical Parameters

The vehicle's towing capacity depends on its specifications, load, road conditions, and trailer characteristics. To ensure safe driving, please avoid speeding or overloading. Refer to the table below for detailed parameters.

Comfort Configuration



Item	Data
Maximum allowable towing mass (with brake) [kg]	1500
Maximum allowable towing mass (without brake) [kg]	750
Maximum tongue load [kg]	75
Maximum overall dimensions (length × width × height) of passenger car-train combination [mm]	14500*2550*4000
Size limits (length × width × height) of center-axle trailers allowed for towing [mm]	12000*2550*4000

Maximum size limit of trailer rear overhang [mm]	3500
Electrical connection connector	13-core "standard" interface in compliance with ISO11446:2004 standard
Tow ball hitch	Complies with ECE R55 A CLASS tow ball size requirements



Comfort Configuration

Maximum permissible towing mass

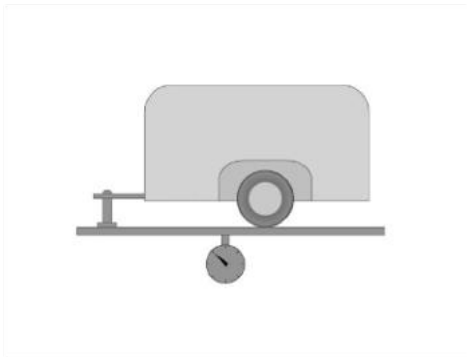

The towing mass denotes the combined weight of the trailer and its cargo.

Maximum tongue load

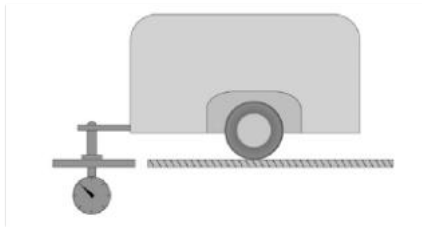

The maximum tongue load represents the highest vertical load allowable at the trailer-hitch connection point.

Trailer taillight power limitation

The power of the trailer's rear lights shall not exceed the specified values below:



- Left/right position lamps: 24W.
- Left/right turn signal lamps: 24W.
- Rear fog light: 42W.
- Reversing light: 42W.
- Brake light: 42W.

Driving Precautions

Starting to Drive

Before driving, please ensure that the tire pressure, lights and connection devices of the tractor and trailer are normal. After connecting the trailer, please turn on “**Trailer Mode**” on the central control screen.

Safely load the trailer cargo, ensuring it is securely fastened in place. Additionally, verify that the trailer is level; otherwise, refrain from driving the vehicle.

Accelerate gradually and avoid sudden acceleration or emergency braking. On slippery road surfaces, such actions could cause the vehicle to lose control due to skidding.

Crosswinds and uneven roads can cause vehicle swaying, significantly impairing vehicular control. In any situation, upon noticing any slight signs of vehicle sway, firmly grip the steering wheel with both hands and gradually reduce your speed. Avoid attempting to counteract the swaying by increasing your speed.

Minimize instances where the tractor is unloaded while the trailer is loaded. If unavoidable due to an unbalanced load distribution, reduce your driving speed.

Brake

When towing a trailer, the braking distance of the vehicle increases. Therefore, increase the distance from the vehicle ahead.

Overtaking

When towing a trailer, the combined length of the vehicle and trailer is extended. Thus, during overtaking, account for a longer passing distance to safely return to your original lane.



Reversing

Reversing when towing a trailer differs from general reversing and is more challenging. Exercise particular caution and practice diligently.

During reversing, hold the bottom of the steering wheel with one hand. Turn your hand to the left to steer the trailer leftward, and turn it to the right to steer the trailer rightward. Ensure reversing at a low speed, and seek assistance from others if possible.

Turning

When towing a trailer, execute turns smoothly, avoid bumps or abrupt maneuvers, and activate turn signals in advance. During turning, the turning radius must exceed that required when not towing a trailer. This ensures the trailer avoids contact with curbs, road signs, trees, or other objects.

Driving on a slope

Slow down in anticipation when towing a trailer on steep or extended slopes. Determine driving speed based on the trailer's weight and the slope's grade.

Try to avoid parking on slopes; if unavoidable, place chocks under the tractor and trailer tires and engage the parking brake.



Opening and Closing of Charging Port Cap

Introduction

You can open/close the charging port cap by the following means:

- Xpeng voice
- Charging port cap switch
- Mobile App
- Smart remote key* [See 197 page](#)
- Central control screen
 - Shortcut panel
 - Bottom status (if set) [See 38 page](#)
 - “ → **Window & Door**” Interface
- Automatic closing

Operation

Charging port cap switch



When the vehicle is unlocked or when carrying a mobile App key (activated for automatic unlocking upon approach), press the upper-left corner of the charging port cap to open it.



Charging Instructions





You can press the switch to close the charging port cap.

Using the intelligent key*

Double-tap the “” key on the intelligent key to open or close “**Charging Port**”.

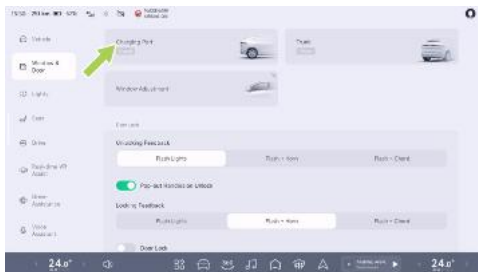
Through the central control screen



- On the central control screen, go to “” → **Window & Door**” interface, and you can open or close “**Charging Port**”.
- Swipe down from the top of the central control screen to access the shortcut panel. On the shortcut panel, you can open or close “**Charging Port**”.



On the central control screen, tap “”, and then tap “**Real-time VR Assist**” in the App Center or tap “**Real-time VR Assist**” (if set) at the bottom taskbar of the central control screen. Enter the Real-time Virtual Reality Assist interface, and tap the icon below the 3D model to open or close the charging port cap, or rotate the 3D model to touch a hotspot icon in the charging port area, and tap the hotspot icon to open or close the charging port cap.

The charging port cap will close automatically

The charging port cap will be closed automatically when any one of the following conditions is met:

- After unplugging the charging gun, lock the vehicle.
- No operation after a period of time, with the charging gun not plugged in.
- When the gearshift lever is not in the P position.

Prompt for charging port cap not closed

When the charging port cap is opened, the 3D vehicle model on the central control screen will display that the charging port cap is in open state. If the charging port cap is not closed while the vehicle is driving, a pop-up alert will appear on the dashboard.



caution

When washing a car, avoid using a high-pressure water gun to impact the charging flap switch area, as this may cause the flap to open.

Tips

After charging, place the sealing cap back into the charging port to prevent foreign objects from falling into it.

Charging Limit

Introduction

Set the charge limit slider to the desired value. The vehicle will automatically stop charging when the charge limit is reached.

The charge limit can be set using the following methods:

- Central control screen
- Mobile App

Operation

Open or close via the central control screen

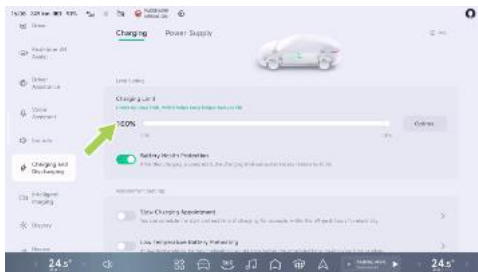

On the central control screen, go to “ → **Charging and Discharging** → **Charging**” interface, and you can set “**Charging Limit**”.

Tips

- To ensure charging speed and to extend battery life, it is recommended that when charging, Select the “**best button for the charging limit**”.

Charging Instructions



- If Battery Health Protection is ticked, the charging limits will return to the default value when the vehicle is repowered.

Charging Control

Introduction

The vehicle supports two charging methods: supercharge and charge.



1. Charge port
2. Supercharge port

Operation

Charging operation steps

1. Bring the vehicle to a full stop and shift to the parking (P) gear.
2. Open the charging port cap [See 312 page](#).
3. Remove the seal cover of the charging port.
4. Press the button on the charging plug and remove its protective cover.



5. Insert the charging plug vertically into the charging port. If you hear a click sound, it



Charging Instructions

indicates the charging plug has been inserted in place.

6. Start charging by following the instructions indicated on the charging pile.
7. If you need to stop charging midway, tap **“Stop Charging”** on the central control screen to end charging.
8. Once charging is complete, press the unlock button on the charging plug and pull it out.
9. Secure the seal cover and close the charging port cap.
10. Return the charging plug to its original position on the charging pile.

warning

- The vehicle may affect medical or implantable electronic devices when charging and discharging, consult the electronic device manufacturer before charging and discharging.
- If a fault occurs during charging, the charging screen will pop up a fault

indication, do not try charging again, contact the XPENG Automobile Service Centre immediately.

caution

- If the slow-charge gun fails to pull out, use the slow-charge emergency unlock pull ring to unlock the gun. Contact your fast-filling carrier when the quick-filling gun fails to pull out.
- Charging or stopping must be done in strict accordance with the operating procedures of the charging pile. Do not plug or unplug the charge gun during charging.

Tips

- The system heats the power battery and automatically enters charging when the specified state is reached.
- When charging a cold ambient gun, there may be situations where the charging efficiency is reduced or the charging is not possible. When the power battery



is discharged and charged in a cold environment, the system heats the power battery to the appropriate temperature when the charge gun is connected before charging the power battery.

- It is recommended to use the Navigation Keep Warm function before fast charging is required in low temperature environments.
- The charging time may vary depending on factors such as outside temperature, battery life or charging current.
- In order to ensure the safety of charging, and to extend the life of the power battery, some DC charging poles will automatically end charging when the power battery is charged to about 95%.

Warnings, Cautions and Limitations

- When taking out the charging plug from the charging pile, please hold it tightly with both hands to prevent the twisted charging cable from rebounding and hitting personnel, causing personal injury.

- Before charging, check whether the charging port, charging gun, and charging plug are dry. Do not operate the charging equipment if it or your hands are wet.
- The charging cable must be laid out smoothly during charging and must not be twisted.
- If the charging equipment shows signs of corrosion or damage, such as deformed or skewed charging gun metal terminals, or cracked or deformed plastic plug components, charging is prohibited.
- In case of an emergency during charging, press the emergency stop button on the charging equipment to stop charging.
- During thunderstorms, it is recommended to stop charging the vehicle, as lightning may damage the charging equipment.
- It is advised to choose shaded charging stations with rain shelters to avoid rain or snow splashing into the charging port when plugging or unplugging the charging gun.



Charging Instructions

- When inserting or removing the charging plug, make sure the vehicle is unlocked. Insert or remove the charging plug vertically; do not insert it at an angle or wiggle it.
- If the charging port emits a strong, pungent smell during charging, immediately stop charging.
- Children must not touch or use the charging equipment.
- If dust, large particles, or hard foreign objects are found in the charging socket, charging gun, or charging plug, clean it after the vehicle is powered off before proceeding with charging.
- If you have an implanted pacemaker, cardioverter defibrillator, pain pump, insulin pump, hearing aid, or other electronic medical devices, do not stay inside the vehicle or enter the vehicle to retrieve items while charging, as this may interfere with electronic medical devices and cause personal injury or death.
- Do not dismantle or modify the charging port or charging cable.
- After charging, please ensure the charging port cap is securely closed to prevent rain, snow, or other debris from entering.
- Due to variations in understanding of national charging standards among charging pile manufacturers and differences in maintenance quality of charging pile products, some charging piles may fail to charge the vehicle successfully. If such an issue occurs, try reinserting the charging plug or switching to another charging pile.

Emergency Unlocking of Charge Port

Operation

Manual emergency unlocking

If multiple attempts to unlock using the emergency button on the central control screen fail, reinsert the charging plug securely and use the following method to remove it:

Charging Instructions



1. Open the trunk and remove the trunk repair cover plate using appropriate tools.

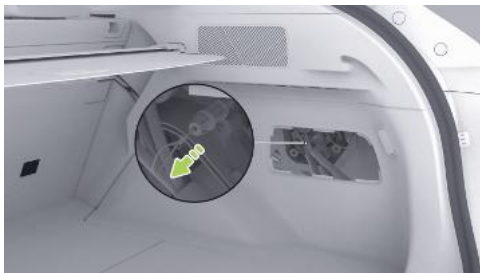

2. Find the emergency unlocking pull ring of the charge port, pull it, and pull out the charging plug once unlocked.

caution

- After the vehicle has finished charging and the CID exits the 'charging/heating up' status display. Only use the emergency unlock pull ring to unlock the charge gun.
- The emergency unlocking of the ring by the charging port is suitable for use in emergency situations and frequent use may damage the emergency unlocking ring or the charging device.
- If you cannot unlock the charge gun using the emergency unlock ring of the charging port, please contact the XPENG Service Center in a timely manner.



Scheduled Charge

Introduction

The charge schedule function allows you to set the vehicle's charging start and end times, utilizing nighttime off-peak electricity rates to reduce charging costs.

You can enable or disable the charge schedule function by any of the following means:

- Central control screen
- Mobile App

Operation

Open or close via the central control screen

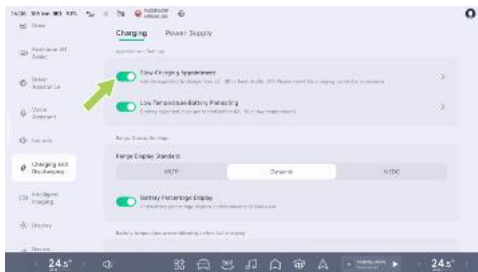

On the central control screen, go to “ → **Charging and Discharging** → **Charging**” interface. You can enable “**Slow Charging Appointment**” and set the charging time.

Tips

Before turning on the slow charge booking charging function in the central control screen, make sure that the charging post booking

Charging Instructions



charging function is switched off in the app side of the phone, otherwise the booking charging is not successful.

⚠ caution

When preheating with a low-temperature battery, lock the vehicle after inserting the charger gun to prevent it from being pulled out by others.

Low-temperature Battery Preheating

Introduction

The low-temperature battery preheating function can heat the battery pack using the AC charging pile's electricity in cold weather. When the battery reaches an optimal temperature, it significantly enhances the vehicle's range in cold conditions.

You can enable or disable the low-temperature battery preheating function by any of the following means:

- Central control screen
- Mobile App

Operation

Open or close via the central control screen

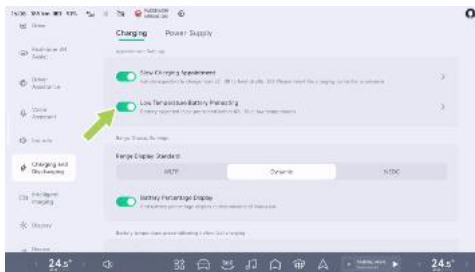

On the central control screen, go to “ → **Charging and Discharging** → **Charging**” interface. You can turn on or off “**Low Temperature Battery Preheating**” and set the preheating duration.



i Tips

The low temperature battery warm-up time is set to finish time.

! caution

- When preheating with a low temperature battery, plug in the gun and lock the vehicle to avoid the AC charger being pulled out by others.
- It is recommended to use the vehicle as soon as possible after the power battery preheating is complete, prolonged parking will reduce the heating effect.
- If the power battery temperature is high, the low temperature battery preheating function will not be activated.
- If you are using slow charge scheduled charging at the same time, make sure that you set the preheating time later than the scheduled charge time.
- Pre-heating of the low temperature battery will slightly increase the AC charging pile

power consumption and should be used as needed.

- If the opening fails, check that the opening conditions for the function are met. Please contact the Xpeng Automobile Service Center in case of abnormal conditions.

Intelligent Insulation for Navigation

Introduction

When central control screen is used to navigate to a fast charging station, the vehicle controls the temperature of the traction battery within the optimal charging range to shorten the charging time.



Operation

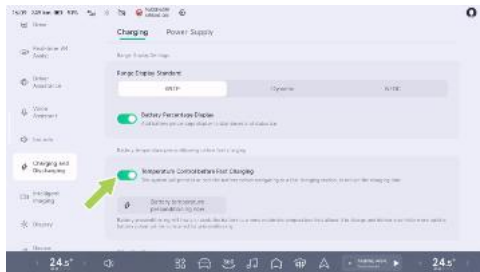

On the central control screen, go to “ → **Charging and Discharging** → **Charging**” interface, and you can turn on or off “**Temperature Control before Fast Charging**”.

When you are heading to a familiar charging station without the navigation feature enabled, you can turn on or off the “**Battery temperature preconditioning now function**” manually or by voice.

Tips

This function heats or cools the power battery and consumes a portion of the power battery's remaining capacity.

External Discharging V2L*

Introduction

In the vehicle, discharging equipment can be used to provide the power of traction battery for other electrical appliances, with a discharge voltage of 220 V and a maximum power of 6 kW.



Operation

Set the external discharge limit



On the central control screen, go to “ → **Charging and Discharging** → **Power Supply**” interface, and you can set “**Power Limit**”. When the traction battery reaches the limit, the power supply will automatically stop.

External discharge operation steps

1. Open the charging port cap.
2. Remove the seal cover of the charge port.

3. Connect the discharging equipment to the vehicle's charge port to start the power supply.
4. Once the power supply is complete, tap “**Stop Power Supply**” on the central control screen.
5. Then, disconnect the discharging equipment.

caution

When the discharge job is to be completed, Please click the “**End Power**” button on the central control screen first. Then unplug the discharge device, otherwise damage to the vehicle may occur.

Cautions and Limitations

Tips

- The external discharge function is not available when the charge is below 20%.
- External discharge equipment (discharge socket, etc.) is not standard and must be purchased.



warning

- The vehicle may affect medical or implantable electronic devices when charging and discharging, consult the electronic device manufacturer before charging and discharging.
- Do not use the external discharge function with damage to the external electrical outlet or discharge device.
- Do not allow minors to touch or use the discharge device, and do not allow minors to come in close proximity when using it.
- Stop using the external discharge function immediately if the power supply is abnormal.
- Do not touch the electrical plug pins and the discharge device sockets.
- Counterfeit products, medical or healthcare electronic devices are strictly prohibited.
- If a fault message appears during power supply, please do not try again and contact the Xpeng Motors Service Center immediately.

Battery Health Protection

Operation



To calibrate the battery, it must be fully charged. If the status bar of the central control screen indicates **"The battery status needs to be calibrated."**, please promptly charge the battery to 100% and perform the calibration.

Tips

When calibrating batteries, it is recommended to use official direct-pit or AC charging piles.



Intelligent driver assistance-hardware

Radar

To ensure the radar operates properly:

- Keep the radar surface clean, free from ice, snow, water, dust, or other debris.
- If foreign objects are found on the radar surface, wipe it with a soft cloth or clean it using water (low water pressure).

Camera

To ensure the camera operates properly:

- Keep the camera surface clean, free from ice, snow, water, dust, or other debris.
- Please keep the front windshield clean.
- Ensure the windshield in front of the camera remains clean and there shall be no object between the camera and the windshield.
- If foreign objects are found on the camera surface, wipe it with a soft cloth or clean it using water (low water pressure).

Open/Close the Front Hood

Operation

Open the front hood



1. Pull the front hood handle located on the lower right side of the dashboard twice consecutively to unlock the hood, which will slightly pop up.



2. Open the front hood upward, and the support rod will automatically hold the hood in position.

Close the front hood



1. Lower the front hood until the hood lock catches the latch.
2. Place both hands on the front edge of the hood (highlighted green area in the figure above), then press downward to close the hood.
3. After closing, ensure the front hood is securely locked. The instrument cluster module will display the opening and closing status of the hood.



Daily Maintenance

warning

- Only apply pressure to the green area shown, the pressure in the red area can cause damage.
- Do not close the front compartment lid with one hand, to avoid concentration of force, which may cause dents or bends.
- Do not press on the front edge of the front compartment lid to avoid bending the edges.

Coolant

Introduction

warning

- To add coolant, open the front compartment cover, contact your XPENG Vehicle Service Center to avoid personal injury from accidental contact with high voltage components.

- Do not unscrew the reservoir cap when the cooling system and coolant reservoir are hot. Under steam and boiling fluid pressure in the hot cooling system, boiling fluid can splash out and burn as soon as the reservoir cap is unscrewed.

Please check the coolant level within the specified maintenance period.



Check the level mark on the side of the coolant reservoir:

- MAX: Upper limit mark

Daily Maintenance



- MIN: Lower limit mark

The coolant level shall be between MIN and MAX marks. If it is lower than the MIN mark, add coolant approved by XPENG in time.

Operation



1. Using the appropriate tools, remove the decorative panel of the front engine compartment to expose the coolant reservoir.



2. Unscrew the reservoir cap and add the coolant.

To maximize the performance and lifespan of the traction battery, motor, and A/C system, the cooling system uses a specific type of coolant (with a freezing point selected according to the local minimum temperature).



Brake Fluid

Introduction

If the brake fluid level in the reservoir is below the required level, the brake light on the instrument cluster will trigger an alarm. If there is an alarm during driving, please stop safely at the roadside. Do not continue driving, and contact the XPENG Service Center immediately.

warning

- If you notice a loose brake pedal or a significant loss of brake fluid, contact XPENG Automobile Service Centre immediately. Driving in these conditions may result in extended braking distances or complete brake failure.
- The brake fluid specification is marked on the brake fluid packaging container and must be used in all cases to the vehicle specification and new brake fluid must be used. Disused or inappropriate brake fluid can worsen braking performance and

even cause brake system failure. The use of genuine XPENG Motors brake fluid is recommended.



Check the level mark on the side of the brake fluid reservoir:

- MAX: Upper limit mark
- MIN: Lower limit mark

The brake fluid level should be between MIN and MAX marks. If it is lower than the MIN mark, add brake fluid approved by XPENG in time.



warning

- Add brake fluid at a level close to MAX (but not beyond the MAX line). Install the cap when the brake fluid has been added.
- Brake fluid is a toxic substance and is subject to environmental regulations when draining or disposing of waste brake fluid.

Operation



1. Wrap a flat-head screwdriver with a cloth, then remove the upper trim of the liquid

storage tank at the location indicated by the arrow in the illustration.

2. Clean the reservoir cap to prevent dust from entering,



3. Unscrew and remove the reservoir cap.
4. Add brake fluid approved by XPENG until the level is near the MAX mark.



Cautions and Limitations

warning

- Use new brake fluid in a closed, air-tight bottle. Do not use brake fluid that has been used or that has been opened from the container. Brake fluid absorbs moisture and reduces braking performance.
 - Brake fluid is highly toxic. The container shall be kept sealed and protected from contact by children. Seek medical attention immediately if you are accidentally ingested.
 - Brake fluid can damage the paint surface, the spillage can be absorbed immediately by an absorbent cloth and washed with a mixture of car cleaner and water.
 - Some models have components in the front compartment that block the brake fluid container and may not be able to precisely check the brake fluid level. If necessary, contact the XPENG Automobile Service Center for assistance with the inspection.
- It is normal for the vehicle to adjust automatically during use due to worn brake friction discs, a slight drop in brake fluid level may be possible, and no concern is required. However, if the fluid level drops significantly within a short period of time, or “”below the MIN mark, Or If the reservoir requires frequent filling, indicating a leaking brake system, contact XPENG Automobile Service Centre as soon as possible to inspect the brake system.
 - The warning light will illuminate if the fluid level drops below the specified height. The instrument cluster may display relevant text messages to warn or warn the driver that certain actions must be carried out immediately. In this case stop immediately, never continue driving and contact XPENG Automobile Service Centre as soon as possible to check the brake system.
 - If the brake system warning light does not extinguish or comes on while driving, the brake fluid level is low and should be



stopped immediately to prevent accidents. Do not continue driving, contact XPENG Automobile Service Centre as soon as possible.

- Brake fluid is water-absorbing and continuously absorbs moisture from the surrounding air during use. If the brake fluid contains too much water, it will corrode the brake system and will also significantly reduce the boiling point of the brake fluid, which can create an air resistance during emergency braking. Reduced braking effect.
- Do not store brake fluid in an empty food container, bottle or any non-genuine brake fluid container, as this may lead to the misperception of brake fluid as food. Cause poisoning!

Refilling of Windshield Washer Fluid

Introduction

Check the washer fluid regularly. If it is found that the Low washer fluid level indicator  illuminates on the dashboard, it indicates the cleaning fluid level is too low. At this moment, you need to add washer fluid to the reservoir in time.

Periodically activate the washer to check for nozzle blockages and ensure proper spray performance.



Operation

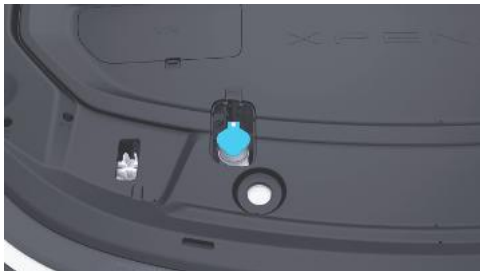

1. Remove the upper trim of the liquid storage tank.
2. Clean the reservoir cap to prevent dust from entering,
3. Open the reservoir cap.
4. Add washer fluid until the fluid level is just below the filler neck.

Cautions and Limitations

warning

- Do not use windshield washer fluids with ethanol content greater than 10%, which may cause lamp cracking in high temperatures.
- Do not spill the windshield washer fluid onto the body panel, if it does, wipe the spill immediately and clean the spill with clean water.



Replacement of Wiper Blades

Introduction



Set the vehicle in the P position and keep the wipers off. On the central control screen, go to “ → **Vehicle**” interface, and you can enable or disable “**Front/Rear Wiper Maintenance Mode**”. The wiper arm will move to its maintenance position, and upon disabling the Wiper Maintenance Mode, the rear wiper arm will automatically return to its original position.

caution

Before replacing the wipers, switch on the wiper service mode with the front compartment lid, main driver door fully closed, damage to the vehicle may occur.

Operation

Replace the front wiper blade

1. On the central control screen, go to “ → **Vehicle**” interface, and turn on “**Front Wiper Maintenance Mode**”. The wiper arms will move to the maintenance position.



2. Lift the wiper arm, press the locking buttons on both sides, release it, and then remove the wiper blade in an upward direction.
3. Install the new wiper blade by following the reverse procedure until you hear a “click”. It indicates proper installation.
4. Gently lower the wiper arm back into the windshield.
5. Turn off “**Front Wiper Maintenance Mode**”.

Replace the rear wiper blade

1. On the central control screen, go to “ →**Vehicle**” interface, and turn on “**Rear Wiper Maintenance Mode**”. The wiper arm will move to the maintenance position.

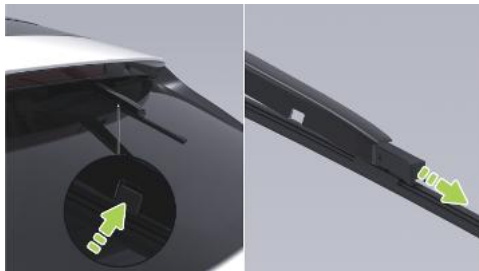

2. Lift the wiper arm, press the locking buttons on both sides, and pull the wiper blade backward to remove it.
3. When installing, lift the wiper arm and insert the protrusion on the new wiper blade into the CAM of the wiper arm. When you hear a “click”. It indicates proper installation.



4. Gently lower the wiper arm back into the windshield.
5. Turn off “Rear Wiper Maintenance Mode”.

i Tips

- If the wiper blades need to be replaced, it is recommended to go to the XPENG Automobile Service Centre for replacement.
- In the case of cleaning the glass, wiper blades or replacing the blades, raise the wiper arms when lifting the wipers, do not grab the blades directly. Avoid deformation of the wiper blades, which can affect the abnormal noise and the performance of the wiper blades.

Traction Battery

Introduction

The traction battery is mounted at the bottom of the vehicle, so drive cautiously!

! caution

- The vehicle has been driven through mud, potholes, curbs, higher, wider creeper belts, Care should be taken on special roads, such as sidewalk ramps, to avoid scratches or damage to the power batteries caused by a collision with the chassis.
- Take care when driving over deep, stagnant water to avoid short circuits, leakage or damage to the power battery due to excessive contact with water.

! warning

If you feel that the chassis has scratched, or the power battery gives off an odor, etc., you should stop using the vehicle immediately and contact the XPENG Automobile Service Center.

Driving range

The driving range is influenced by factors such as the remaining traction battery charge, total mileage and time, ambient temperature, road



Daily Maintenance

conditions, driving habits (use of A/C, driving mode, regeneration level), and the vehicle's load.

Ambient temperature

Ambient temperature affects the performance of traction battery. The vehicle should be used in temperatures ranging from -30°C to 60°C to maintain optimal battery performance and extend its lifespan.

Do not expose the vehicle to temperatures above 60°C or below -30°C continuously.

Traction battery maintenance

The traction battery will discharge slowly, even if the vehicle is not in use. The lifespan and performance of traction battery will be reduced if the battery level is too low, shortening the vehicle's driving range. Therefore, before long-term parking, check the remaining battery charge and maintain it at 30%-60%. If the charge is insufficient, recharge to meet the parking requirement before leaving the vehicle.

Please refer to the chart correlating battery level and parking duration to ensure sufficient charge for parking:

Driving range or battery level	30%	50%	60%
Parking days	≤ 90	≤ 150	≤ 180

It is recommended to power up and check the battery every three months. If the battery level is too low, recharge promptly to avoid performance degradation due to undervoltage.

The lifespan of traction battery is also impacted by the ambient temperature. When the ambient temperature is low, the vehicle's driving range may decrease and charging time will increase.



i Tips

- Recommended charging operating ambient temperature: 0 to 45°C. °The charging time will be extended when the operating ambient temperature is below 0 C.
- Long-term parking in hot or cold conditions can result in accelerated power battery wear and it is recommended to park in a cool, dry and ventilated area, avoiding heat sources (e.g. heating pipes) and low-lying areas. Keep away from flammable explosives, corrosive substances.
- Avoid long distances or long periods of wading.
- Do not discharge the power battery completely.

- After taking delivery of the vehicle, charge the battery to 100% as soon as possible (for the first three charges, it is recommended to supercharge the vehicle to 100%). During regular use, always keep the charge limit set to 100%, and fully charge the battery to 100% at least once every two weeks or 1,000 km (both charge and supercharge are acceptable).
- Recharge promptly if the vehicle's driving range drops below 30 km or if it has been parked for more than a week.
- In winter, when temperatures are lower, it is recommended to maintain a remaining range of no less than 100 kilometers.
- During vehicle parking, avoid prolonged use of the sentry mode or the trunk 12V delayed power-off function to reduce battery consumption.

Maintenance of lithium iron phosphate battery

For vehicles equipped with lithium iron phosphate batteries, follow these recommendations to accurately estimate driving range and maintain traction battery health:



Charging Base

Introduction

Under normal use, clean the charging base and charging plug weekly using a high-pressure air gun or a brush. If these tools are unavailable, use a lint-free cloth or cotton swabs for cleaning.

warning

- Never touch the charger barrel and socket with sharp objects such as screwdrivers or tweezers to avoid damaging the socket and socket.
- When a foreign object enters deep into the charging base, it must be cleaned by a professional.

caution

Do not use force to pull the gun when it does not pull properly after the slow charge is finished, try using the slow charge port to emergency unlock or contact the XPENG Automobile Service Center.

Tires

Introduction

Inspection and maintenance of tires

Check tire pressure regularly and, if inflation is needed, follow the tire pressure specifications on the label on the driver-side B-pillar to adjust it.

Inspect tire treads regularly for abnormal wear, punctures, or nails. Regularly check the tire sidewalls for bulges, cuts, or other damages.

Tire wear

Adequate tread depth is crucial for tire performance. When driving in normal or harsh conditions, continuously using tires with shouldow tread patterns or exposed wear marks is more likely to cause slipping, extended braking distances, steering failure, and tire rupture, which could easily lead to accidents and should be avoided.

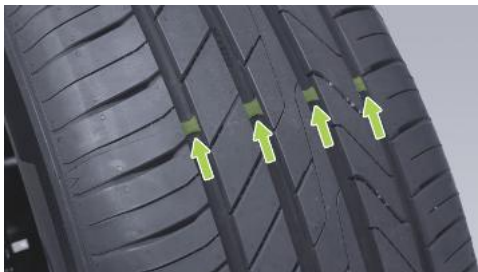

i Tips

The wear is marked as a schematic and is for reference only, depending on the actual vehicle.

The wear mark, which is a transverse rib evenly distributed along the circumference of the tire in the tread grooves, measures 1.6 mm in height. This wear mark is used to indicate whether the tire is excessively worn. Tires worn to this wear mark must be replaced.

! warning

- Tires must be replaced when worn to the wear mark.
- Severe wear tires are less safe and less powerful even before the wear mark is reached. Especially on slippery surfaces, it increases the risk of slipping phenomenon, seriously affecting driving safety.

To reduce tire wear and extend tire life, maintain tires based on your driving habits and road conditions:

- Avoid rapid acceleration.
- Avoid sharp turns and hard braking.
- Drive slowly over potholes, curbs, or similar obstacles.
- If uneven tire wear is observed, perform a four-wheel positioning inspection.

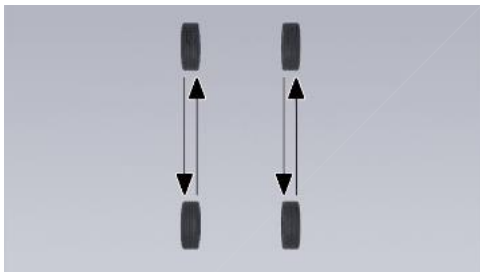

i Tips

The tire pressure sensor ID will need to be rewritten after tire rotation, to avoid abnormal TPMS operation please go to XPENG Automobile Service Center for tire rotation.

Tire and wheel replacement

Due to exposure to UV rays, extreme temperatures, heavy loads, and environmental conditions, tires naturally age over time. Normal tire wear occurs during regular driving, including

acceleration, braking, and cornering. XPENG Service Center will inspect tire wear during maintenance and recommend tire replacement if necessary. In special cases, such as when the tread wears down to the wear indicator, or if the tire surface is scratched or punctured, immediately visit XPENG Service Center to replace the tire.

⚠ caution

Use the same tires and wheels as the original vehicle configuration. Tyres that do not match the original specification may affect the operation of the Intelligent Driving Assistance and Tire Pressure Monitoring System.

⚠ warning

- Do not drive the vehicle if the tires are damaged, excessively worn or the air pressure is incorrect. Regularly check the tire for wear and make sure there are no cuts and bulges.



- Wheel balancing must be re-performed after a new tire has been replaced or after a tire repair has been carried out.

Seasonal tire types

Summer tires

Summer tires are designed for extremely dry and wet road surfaces but are not suitable for winter conditions. For driving in low temperatures or on icy and snowy roads, it is recommended to use winter tires.

All-season tire

This type of tires are specifically designed to provide adequate traction in all seasons of the year. However, they may not offer the same level of traction as winter tires on icy and snowy roads. All-season tires are marked with “**ALL SEASON**” and/or “**M+S**” (mud and snow) logo on the sidewalls.

Winter tires

Winter tires can enhance traction on icy and snowy roads. When installing winter tires, ensure that a full set of four tires is installed. All four tires must be of the same specification, brand, construction, and tread pattern. Contact XPENG Service Center for advice on winter tires.

When driving a vehicle equipped with winter tires, increased road noise, shorter tread life, and reduced traction on dry roads may occur.

warning

- If you notice uneven and excessive tire wear, you should go to XPENG Automobile Service Centre as soon as possible to check the wheel balance, four wheel alignment.
- Insufficient tire pressure is the most common cause of tire failure and can cause tire overheating, tire cracking, tread layering or tire burst causing unexpected loss of vehicle control. Increase risk of injury.
- Low tire pressure can also reduce vehicle range and tire tread life.



- Do not use tire sealant as this may cause tire pressure sensor failure.

Brake Pad

Introduction

It is recommended to check whether the brake pads are worn to the alarm plate position during each maintenance or long-distance driving.

If unusual noises occur during braking, check the brake pads and replace them if they are worn to the alarm plate position.

The brake pad should be replaced with the original equipment. During replacement, ensure copper grease is evenly applied to the contact points between the brake pad lugs and the caliper.

Vehicle Cleaning

Exterior Cleaning

Exterior Cleaning

Frequent vehicle washes help protect the vehicle's appearance.

Wash the vehicle in a shaded area and only after the vehicle has cooled down to prevent damage to the paint caused by direct sunlight.

Follow the vehicle washer operator's guidance when using an automatic vehicle washer.

During high-pressure washing, please direct the spray toward the glass, and do not use water to wash the interior of the vehicle towards the edge of the glass.

In winter, dry the seams around the door handles after washing to prevent them from freezing.

Promptly remove corrosive substances (bird droppings, tree sap, insects, tar spots, road salt,



industrial dust, etc.) to prevent damage to the paint.

When cleaning the exterior of the vehicle body, please follow these steps:

1. Preparation before cleaning

Close all doors, the trunk, and the front hood. Check whether the charging port cap is completely closed.

2. Thorough rinse

Before washing, use a hose to rinse off dirt and grit from the exterior of the vehicle body. Please pay extra attention to areas prone to dust, mud, or road salt accumulation (such as wheel arches and panel seams).

3. Hand wash

Mix a high-quality neutral vehicle cleaner with cold or warm water. Use a soft cloth to hand wash the exterior of the vehicle body.

4. Rinse with clean water

After washing, rinse thoroughly with clean water to prevent soap residue from drying on the surface.

5. Dry with soft cloth

caution

- Do not use hot water and detergents.
- If a high pressure washer is used, keep the nozzle at least 30 cm from the surface of the body, keep the nozzle moving, and do not spray the water at any point. Do not spray the nozzle toward the charging port.
- The active grille vanes may not function properly due to icing when washing in cold temperatures or when parked outdoors on a snowy day, the instrument cluster indicates an active grille fault. This is normal and does not affect the normal use of the vehicle, the fault disappears automatically after a period of normal driving (approximately one hour) or thawing with a hot air gun. If the problem persists after thawing the blades, please



contact the XPENG Automobile Service Center for repair.

- Do not spray hoses directly toward windows, door seals or through hub bores into the brakes.
- Avoid using cotton fleece or a rough cloth, such as car wash gloves.
- Do not use chemical tire cleaner as this may damage the finished surface of the wheel.
- When washing a car, avoid using a high-pressure water gun to impact the charging flap switch area, as this may cause the flap to open.
- Avoid using ethanol or ethanol based wash fluids when washing the vehicle, as this may cause damage to surfaces such as lamp covers, paints and wipers.

Cleaning and maintenance of exterior plastic parts

It is usually cleaned with clean water, soft cloth and soft brush.

Cleaning of windows and rearview mirrors

Use an alcohol-based glass cleaner to clean windows and rearview mirrors, and then dry the surface with a clean and lint-free soft cloth.

If wax from body surface treatments remains on the glass, remove it using specialized cleaner and cleaning cloth to prevent damaging the wiper blades.

Use a small brush to remove snow from windows and rearview mirrors.

Use a de-icing spray to remove ice, or carefully use an ice scraper, taking care to avoid damaging components and scraping in the same direction.

caution

- Do not use warm water or hot water to remove ice or snow from the windshield and mirrors, as this may cause the glass to burst.
- If rubber, grease and silicone residues are present on the glass, they must be removed



with special window cleaner or silicone cleaner.

Maintenance of sealing strips

Use a soft cloth to remove dust and dirt from seal surfaces during sealing strip maintenance. Regularly apply special protective agent to the rubber sealing strip

Wiper blade cleaning

Regularly inspect and clean the edges of the wiper blades. Check for rubber cracks, tears, and roughness. If damaged, contact the XPENG Service Center for replacement.

Wiper performance may decrease due to contaminants on the wiper blade, such as ice, vehicle-washing wax, cleaning fluids containing bacteria or water repellents, bird droppings, leaves, and other organic materials.

Clean wiper blades as follows:

- Use a non-abrasive glass cleaner to clean the windshield.

- On the central control screen, go to “ →**Vehicle**” interface, and turn on “**Front/Rear Wiper Maintenance Mode**”.
- Slightly lift the wiper arms off the windshield, just enough to access the wiper blades. Use isopropyl alcohol or wiper cleaning fluid to clean the wiper blades thoroughly.
- If the wiper blade still does not function after cleaning, it may need to be replaced.

caution

- Use care when placing the wiper arms to prevent an instant drop on the windshield.
- The wiper blade is coated with a layer of graphite to smooth the wipe level without any scratching noise. Solvent-containing cleaning agents, hard sponges and sharp tools can damage the graphite layer. A damaged graphite layer will cause excessive wiper scraping noise and should be replaced promptly.
- In winter or cold conditions, always check that the wiper blades are frozen with the



windshield before using the wipers. If so, de-ice the wiper blade and wiper motor damage will occur.

- In the case of cleaning the glass, wiper blades or replacing the blades, raise the wiper arms when lifting the wipers, do not grab the blades directly. Avoid deformation of the wiper blades, which can affect the abnormal noise and the performance of the wiper blades.

Cleaning of windshield

Use a specialized cleaner to clean the windshield.

Contaminants on the windshield may affect its hydrophilic properties; clean them promptly. Contaminants include dust, oil films, bird droppings, leaves, and other debris.

caution

- Do not use cleaning products that contain ammonia or chlorine, such as household

window cleaners, which can accelerate the aging of the wiper strips.

- Do not use water-resistant materials (e.g. waxing, crystallizing, etc.) to clean the window glass, which will increase the water resistance of the glass surface and affect the cleanliness of the window glass.

Interior Trims Cleaning

Regularly inspect and clean the interior trims to maintain a neat and new appearance and prevent premature wear.

caution

- It is recommended to use automotive products without plasticizer, if the plastic content of automotive products is too high, will react with PU material interior, resulting in the appearance of the bulging of the interior.
- To avoid interference with the pedal, make sure that the driver's floor mat is secured properly and never overlaid. The floor mats



should always be placed on the surface of the vehicle carpet.

- Use solvents (including alcohol), bleach, citrus cleaners, naphtha, Silicone based products or additives can damage the interior.
- Substances with static electricity can cause damage to the CID and the instrument.
- Do not use wipes, damp cloths, cleaning agents, etc. to wipe the door covers and do not use them during vehicle use (e.g. in rainy days, When washing the car) take care to protect the door guard from water ingress as much as possible, which could cause internal electrical component failure, etc.
- If any damage is found to the airbag or seat belt, contact the XPENG Vehicle Service Centre immediately.
- Do not allow any water, detergent or fabric to enter the seat belt unit.

Interior trims glass

It is strictly prohibited to scratch the glass or mirror surface or to use any abrasive cleaning solution. Otherwise, the mirror reflective surface and rear window heating elements may be damaged.

IP and plastic surfaces

It is strictly prohibited to polish the upper surface of the IP, because the polished surface is easy to reflect light and may interfere with the driving vision.

Seat cleaning

If seats are stained, use a soft cloth dipped in warm water and neutral soap solution to gently wipe in circular motions, and then dry with a lint-free soft cloth.

Seat Belt

Pull out the seat belt and wipe it without using any detergent or chemical cleaner. Pull out the seat belt and allow it to air dry naturally.



Carpet

Use a vacuum cleaner with a soft brush head to remove dust and scum. For stubborn stains, try to remove them with water or soda water first. Before cleaning, please use an appropriate method to remove stains:

- For liquid stains: Gently blot with tissue paper to absorb as much of the stain as possible.
- For solid, dry stains: Manually remove as much as possible, and then use a vacuum cleaner.

central control screen and dashboard

Clean the central control screen and dashboard with a special clean lint-free soft cloth. Do not use cleaners (for example, glass cleaners), wet cloths, or static-laden dry cloths (for example, freshly washed microfiber cloths).

On the central control screen, go to “ → **Display**” interface, or via the shortcut panel of the central control screen, enable “**Screen Cleaning**” before wiping the central control

screen so that buttons will not be activated and setting values remain unchanged.

caution

Do not use acid-alkali, deoxygenation, sodium hypochlorite (84 disinfectant) and other corrosive liquids to clean the CID.

Chrome-plated and metal surfaces

Polishes, abrasive cleaners, or hard cloths can damage the finish of chrome-plated and metal surfaces.

Foot pad

To extend the lifespan of the carpet and facilitate cleaning, use genuine XPENG-approved foot mats. Regularly clean the foot mats and ensure they are properly installed. Replace foot mats promptly if they become excessively worn.



Emergency Device

Emergency Device Information

Hazard warning light



In case of emergency while driving, press the hazard warning light switch to activate the hazard warning light. The turn signal will flash. Press the switch again to deactivate the hazard warning light.

i Tips

The hazard warning lamps can be activated whether the vehicle is powered on or powered off.

Emergency power-off switch



Specific operations [See 220 page.](#)



Front emergency door release handle



Specific operations [See 211 page.](#)

Rear emergency door release pull ring



Specific operations [See 211 page.](#)

Emergency Rescue



Trunk emergency open switch

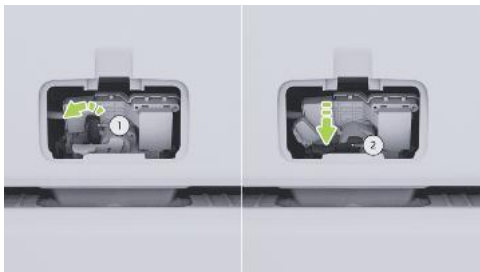

Specific operations [See 214 page.](#)

Trunk emergency device

The on-board tools are located beneath the trunk lid. Open the trunk and lift the cover to access them.

This vehicle is equipped with the following on-board tools. After use, clean them promptly and return them to their designated places.

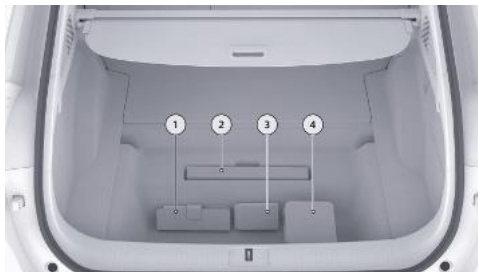

1. On-board tools: trailer hook, wheel nut wrench
2. Warning triangle
3. Reflective vests

When encountering an issue requiring you to stop while driving, retrieve the reflective vest from under the trunk lid and wear it properly.

i Tips

- When wearing a reflective vest, wear the side of the reflective material on the outside.



- If the Reflective Vest is broken or soiled, replace it with a new one.

warning

When dealing with vehicle accidents, regardless of the lighting conditions, always wear reflective clothing as required to attract the attention of passers-by or other vehicle drivers.

4. Emergency inflation and tire repair tools

Instructions for installing the warning triangle

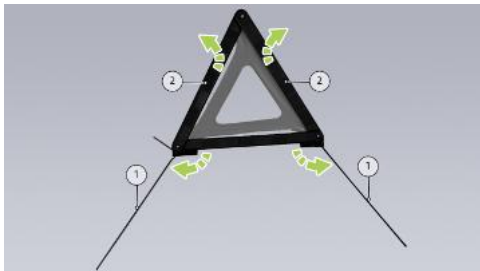

1. Unfold the 4 brackets ① located at the bottom of the warning triangle.
2. Unfold the folded edges ② on both sides of the warning triangle and fasten its top buckle securely.
3. Place the bracket on the ground with the reflective material side facing the rear.

The placement distance of the warning triangle behind the vehicle varies with road surface type and environmental visibility. Refer to the following table:

Road	Placement distance	
	Daytime	Night time
Expressway	≥ 150m	≥ 150m
General highway	≥ 50m	≥ 80m



Temporary Tire Repair

Temporary Tire Repair

The vehicle is not equipped with a spare tire. An emergency tire repair kit is provided with the vehicle.

The emergency tire repair kit includes an inflator and a canister of tire glue (sufficient to repair one tire). When injecting the tire, the tire glue will seep into small punctures in the tire with a maximum size of 6 mm, serving as a temporary fix.



warning

- For perforations larger than 6mm, severe tread damage, sidewall damage, tire tearing or tire falling out of the wheel, Please contact XPENG Automobile Service Center.
- The inflatable tire repair emergency kit is only intended for a single temporary tire



repair and must be repaired or damaged tires replaced as soon as possible.

- If a tire has been temporarily repaired with tire repair glue, the driving speed must not exceed 80 km/h.
- Read and follow all warnings and tips on the inflatable tire repair emergency kit.
- Do not continue driving when you notice a flat tire, as serious injury may result.

Tire Glue

The tire glue provided in the emergency tire repair kit is specially designed for XPENG vehicles and will not damage the tire pressure sensors. Therefore, only the same type and capacity of tire glue shall be used for replacement. Tire glue can be purchased from XPENG Service Center.

The expiration date is printed on the tire glue container. If the expiration date has passed, the tire glue may lose its intended effectiveness. Be sure to purchase new tire glue.

warning

- Do not use tire repair glue purchased from other sources as this may cause tire pressure sensor failure.
- Always read and follow the safety and operating instructions for tire repair glue.
- Protect children from contact with the tire hydration.
- If your eyes come into contact with the tire repair glue, rinse immediately with clean water and seek medical attention.
- If you accidentally eat the tire supplement, seek medical advice immediately.
- If you accidentally inhale the tire repair glue, breathe fresh air immediately to avoid breathing and seek medical attention immediately.

Tire Inflation

Follow the steps below to temporarily repair small tire punctures (less than 6 mm):

Emergency Rescue



1. Remove the emergency tire repair kit from the trunk.

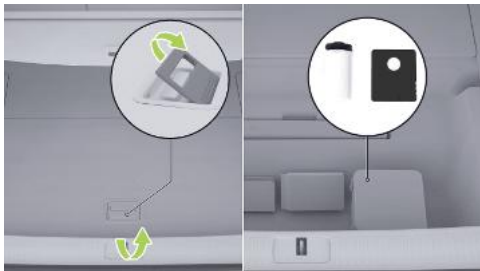

2. Take out the inflator and tire glue from the kit.

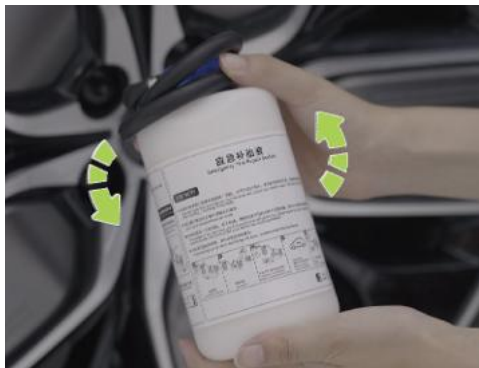

3. Take out the tire glue container and shake it evenly.



4. Screw one end of the tire glue connecting hose tightly onto the tire valve. Ensure the tire glue container is not inverted.



5. Connect the other end of the tire glue hose to the inflator and tighten it, and connect the power cord of the inflator to the 12V power supply in the vehicle storage box.

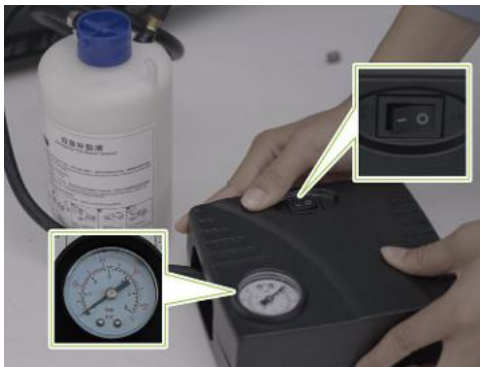

6. a. Turn on the switch to start the inflator, which will inflate the tire.
- b. During the tire glue injection process, the pressure gauge shows a pressure range of approximately 300-600 kPa.
- c. Observe the pressure gauge and stop inflating once the tire pressure reaches the standard value.

- d. Refer to the tire pressure label for the standard tire pressure of the specific tire specification.
 - e. Check the tire pressure. If the tire cannot reach the specified pressure within 20 minutes, the repair is considered unsuccessful.
7. Turn off the inflator and disconnect the hose from the tire valve. Wipe off any excess tire glue from the tire valve and the hub. Disconnect the hose from the inflator, and return the emergency tire repair kit to the trunk.
 8. Drive immediately for 5 km or 10 minutes to allow the tire glue to distribute evenly inside the tire. Maintain a speed of 20-60 km/h.
 9. Stop and check the tire pressure.

⚠ caution

If the tire pressure is below 130kPa, damage to the tire cannot be repaired with tire repair fluid, please stop the vehicle



safely at the roadside and contact the XPENG Vehicle Service Centre.

- Inflate the tire to the standard pressure.
- Store the inflator back in the trunk.
- Drive the vehicle to XPENG Service Center at a speed of 20~80 km/h for tire repair.

caution

- Repair or replace tires as soon as possible.
- After the use of the tire repair glue, the new tire repair glue should be purchased in time.
- Do not exceed 80km/h.

Inflation Only

- Remove the emergency tire repair kit from the trunk.

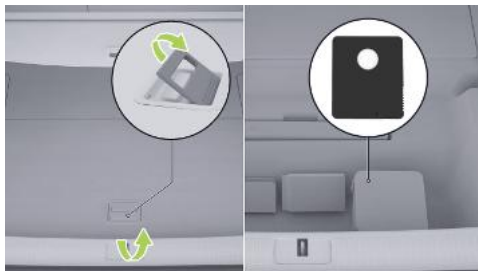

- Take out the inflator from the emergency tire repair kit.



3. Take out the connecting hose and power cord from both sides of the inflator.
4. Attach the inflator connecting hose to the tire valve and tighten it.
5. Connect the power cord of the inflator to the 12V power supply of vehicle.



6. Turn on the switch to start the inflator, which will inflate the tire.
 - Observe the pressure gauge and stop inflating once the tire pressure reaches the standard value.
 - Refer to the tire pressure label for the standard tire pressure of the specific tire specification.



7. Turn off the inflator.

caution

- Inflate to the standard tire pressure value, otherwise the tire pressure is too high or too low and can cause faster tire wear.
- If the tire pressure is too high, the tire pressure value can be reduced by deflating air.
 - Procedure: Remove the pneumatic hose and press and hold the metal bar in the center of the valve to deflate while connecting the pneumatic hose reads the gauge until the tire pressure decreases to the standard tire pressure.

- If the tire pressure monitoring system indicator does not extinguish after adjusting the tire pressure, drive at 40km/h for a short period of time and watch for the indicator to recover.
- It is normal to have a slight increase in tire pressure as the temperature of the tire increases after the vehicle has been driven for some time.
- If the indicator light is still on, contact the XPENG Automobile Service Center.

Rescue and Protection Equipment

Introduction

The vehicle is battery-driven, and serious impact may lead to the leakage of high voltage. For this reason, vehicle rescue should be performed by professionals wearing appropriate personal protective equipment.



warning

When working on the vehicle, make sure that you do not carry metal items (e.g. necklaces, watches, etc.) to avoid electrical shock.

Protecting against electrical injury

To avoid high-voltage electrical injury, wear the following personal protective equipment:

- Rubber insulating gloves (for voltage above 500V);
- Goggles;
- Insulating rubber shoes;
- Tools with insulating sleeves.

Protecting against chemical injury

If the traction battery leaks electrolyte, wear the following personal protective equipment to protect your skin, face, and other body parts from injury:

- Protective mask;
- Solvent insulated gloves;



Protection Against Crash

Introduction

The vehicle features high-voltage cutoff and discharge functions. In case of a crash, if the trigger conditions are met, the vehicle will automatically cut off the high-voltage power supply and instruct the occupants to immediately exit the vehicle to prevent risk to their safety.

Jump Start

Operation

When the LV battery is low, the traction battery will automatically charge the LV battery. However, if the traction battery is low, the charging to the LV battery will be ceased to prevent damage from over-discharging the traction battery. Once the vehicle is locked, the anti-theft system begins operation, continuously consuming power of the LV battery. If the vehicle is not charged timely, it may lead to the vehicle being unable

to unlock or start due to the depletion of the LV battery.

If the vehicle cannot be started due to the depletion of the LV battery, it can be started using an external 12V DC power source.

1. Open the front trunk and remove the maintenance cover plate.



2. Open the fuse box cover plate of front trunk.

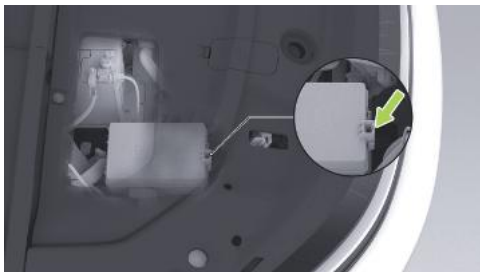

3. Connect one end of the red cable to the positive stud (+) of the vehicle's fuse box, and the other end to the positive terminal (+) of the auxiliary power supply.

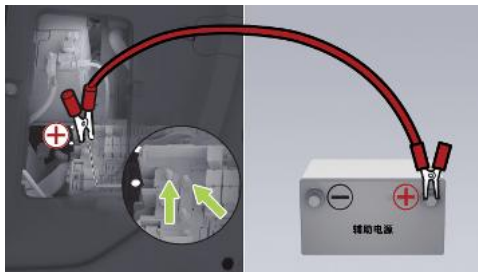

4. Connect one end of the black cable to the negative terminal (-) of the vehicle's battery, and the other end to the negative terminal (-) of the auxiliary power supply.

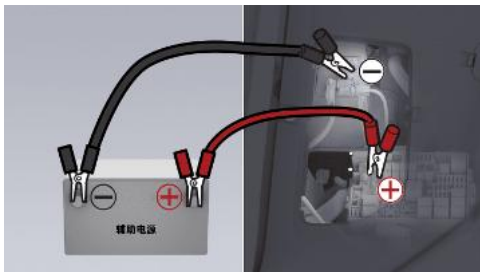

5. After connecting the auxiliary power, if the dashboard or central control screen is still illuminated, you need to press the emergency power-off switch first to power off; otherwise, the vehicle won't start. After power-off, make sure the remote control key* or NFC card key is inside the vehicle, or that the phone key is connected to the vehicle. Then, you can press the brake pedal and shift into gear to start the vehicle.

caution

Emergency auxiliary power, can not maintain high power output for a long period of time, generally to complete the auxiliary power - restart operation within 30 s, otherwise to carry out the power-back operation.

6. Start the vehicle. Once it successfully starts, disconnect the cables in the reverse order and reinstall the maintenance cover plate.

warning

- Improper use of the connecting cable can cause the battery to explode and cause personal injury.
- The auxiliary supply voltage must be the same as the voltage and capacity of the vehicle battery, otherwise an explosion may occur.
- The battery must not come into contact with naked flames or static electricity, otherwise the combustible gas produced by the



battery may be ignited by sparks, causing an explosion.

- Do not touch high voltage components during operation, be careful to avoid injury from high voltage electrical shock.

E-call*

Introduction

E-call is the vehicle's intelligent emergency call system that automatically or manually dials emergency services when accidents or emergencies occur, providing vehicle location and passenger injury information to help rescue personnel reach the scene promptly and assist trapped occupants.

Operation



In case of an emergency, the following methods can be used to call for assistance:

- Manual call: Press and hold the SOS switch for more than 3 seconds to initiate an emergency call. If you wish to cancel the call while waiting for a connection, press the switch again.
- Automatic call: When the vehicle is involved in a crash that triggers airbag deployment, the system will automatically initiate an emergency call.



- Callback: If the call is not connected or is interrupted, the system supports call redial within a certain period.

i Tips

- The SOS switch indicator lights up green when Call Assist is waiting or switched on. The SOS switch indicator illuminates red in the event of a system fault and you should seek assistance by other means.
- Once Call Assist is switched on, the call can only be ended by the donor.
- Call Assistance is beyond its expiration date and no further service can be provided, please follow the Call Assistance expiration date in time on the central control screen.
- In the event of battery failure, Call Assist can continue to support a call for a period of time.

Vehicle Information



Vehicle Parameters

Dimensions

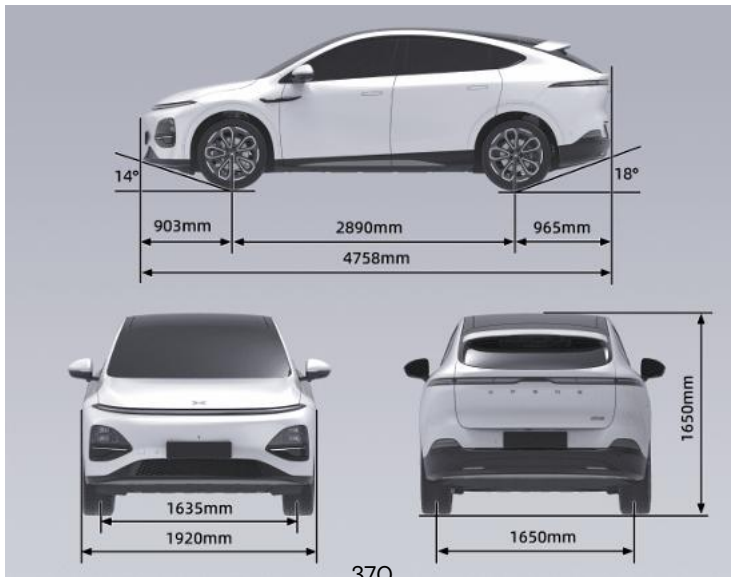



Vehicle Information

Dimension	Length (mm)	4758
	Width (mm)	1920
	Height (mm)	1650
Wheel track	Front track (mm)	1635
	Rear track (mm)	1650
Wheelbase (mm)		2890
Front suspension (mm)		903
Rear suspension (mm)		965
Number of occupants		5
Approach angle (full load) (°)		14
Departure angle (full load) (°)		18



i Tips

The exterior rearview mirrors (one on each side) are not included in the exterior width. The tolerance of the vehicle's dimensional parameters is $\pm 1\%$.

Weight

Item Name		2WD long range	2WD ultra-long range	4WD ultra-long range
Vehicle curb weight (kg)		2065, 2085 (towing hook)	2115, 2140 (towing hook)	2220, 2240 (towing hook)
Curb	Front axle (kg)	979, 969 (towing hook)	984, 978 (towing hook)	1088, 1080 (towing hook)
	Rear axle (kg)	1086, 1116 (towing hook)	1131, 1162 (towing hook)	1132, 1160 (towing hook)
Gross vehicle mass (kg)		2535	2590	2690
Maximum	Front axle (kg)	1090	1098	1200
	Rear axle (kg)	1445	1492	1490



i Tips

The mass parameter tolerance range is $\pm 3\%$, except for the maximum total mass.

Vehicle Information



Performance Parameters

Minimum turning diameter (m)	11.6
Maximum speed (km/h)	202
Maximum gradient (%)	30



Wheels and Tires

Tires		235/60R18	255/45R20
Wheel rim		18×7.5J	20×8.5J
Pressure	Front wheels (no-load/ half-load/full-load) (kPa)	250	
	Rear wheels (no-load/ half-load/full-load) (kPa)	270	
Wheel balancing (after attaching balance weights)	Front wheels, inner side (g)	≤8	
	Front wheels, outer side (g)	≤8	
	Rear wheels, inner side (g)	≤8	
	Rear wheels, outer side (g)	≤8	



Brake and Suspension

Type	Floating caliper ventilation disc type
Boost type	Electric power steering
Brake pedal free stroke or idle stroke (mm)	≤2
Wear limit of brake pad for front wheel (excluding the backing plate for brake pad) (mm)	1
Wear limit of brake pad for rear wheel (excluding the backing plate for brake pad) (mm)	3.3
Wear limit of front brake disc (mm)	26
Wear limit of rear brake disc (mm)	20
Front suspension type	Double-wishbone independent suspension
Rear suspension type	Multi-link independent suspension



Four-wheel positioning specifications

Single front wheel toe-in	$0.15^{\circ} \pm 0.05^{\circ}$
Single front wheel camber	$-0.5^{\circ} \pm 0.5^{\circ}$
Single kingpin caster angle	$6.8^{\circ} \pm 1^{\circ}$
Single kingpin inclination angle	$10.2^{\circ} \pm 1^{\circ}$
Single rear wheel toe-in	$0.1^{\circ} \pm 0.05^{\circ}$
Rear wheel camber	$-1.36^{\circ} \pm 0.5^{\circ}$



Electric Drive System Parameters

Drive configuration	Long range 2WD	Ultra-long range 2WD	Ultra-long range 4WD	
Item Name	Rear electric drive system	Rear electric drive system	Front electric drive system	Rear electric drive system



Vehicle Information

Electric motor	Type	Permanent magnet synchronous	Permanent magnet synchronous	AC asynchronous	Permanent magnet synchronous
	Rated power (kW)	110	110	50	110
	Rated torque (N·m)	170	170	50	170
	Rated speed (rpm)	6190	6190	7300	6190
	Maximum power (kW)	185	218	140	218
	Maximum torque (N·m)	440	440	220	440
	Maximum speed (rpm)	18000	18000	18000	18000
Reducer	Model	1ETP45A	1ETP45A	1ETP22A	1ETP45A
	Number of gears	1	1	1	1



Seat Adjustment Parameters

In the initial position, the adjustment parameters of the seat are as follows:

Seat type	Item	Parameter
Driver's seat	Forward and backward adjustment	Total stroke: 260 mm; 212 mm forward, 48 mm backward
	Backrest adjustment	Total stroke 91°, 16° forward and 75° backward
	Up/down adjustment	Total stroke 69.5mm, 35.6mm upward and 33.9mm downward
	Cushion adjustment	Total stroke is 6°, with 5° upward and 1° downward



Vehicle Information

Front passenger's seat	Forward and backward adjustment	Total stroke: 260 mm; 212 mm forward, 48 mm backward
	Backrest adjustment	Total stroke 91°, 16° forward and 75° backward
	Up/down adjustment	Total stroke 69.5mm, 35.6mm upward and 33.9mm downward



Fluids and Capacity

Introduction

Item Name	Model		Filling amount
Front electric drive lubricating oil* (L)	FUCHS 4101		1.40L
Rear electric drive lubricating oil (L)			2L
Coolant (L)	Mixture of glycol and water	2WD model	Approx. 14.8L
		4WD model	Approx. 15.2L
A/C refrigerant (g)	R1234yf*		1150±15
	R134a*		1250±15
Brake fluid (L)	DOT4		1.04L
Windshield washer fluid (L)	/		3



Nameplate and Labels

Vehicle Identification Number (VIN)



The vehicle identification code is engraved on the right tower seat of the front cabin aluminum casting.

Other VINs are located in the following positions of the vehicle:

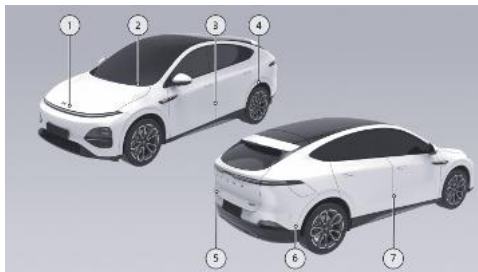

1. Affixed to the inner side of the hood.
2. Affixed to the lower-left corner of the front windshield.
3. Affixed to the left B-pillar.
4. Affixed to the rear left wheel house.
5. Affixed to the left side of the trunk lid.
6. Affixed to the front cross member of rear floor.
7. Affixed to the inner panel of the rear right door.

Vehicle Information



OBD diagnostic port

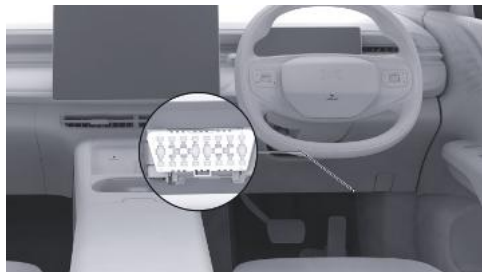

The OBD port for reading the electronic VIN is located at the lower right of the instrument cluster. The electronic VIN, vehicle status information and other data can be read with the original manufacturer's diagnostic apparatus or diagnostic equipment officially approved by the original manufacturer.

Vehicle Product Nameplate



The product nameplate is located on the passenger side B-pillar and can be viewed after opening the passenger side door.



Electric Motor Model and Number

Front electric motor*

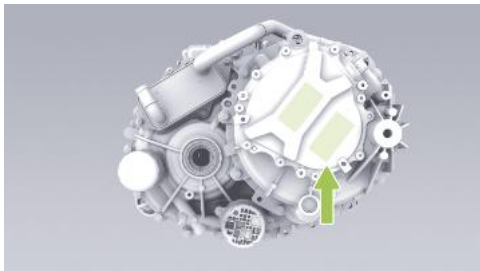

The drive motor model and serial number are displayed on the drive motor housing and the drive motor label.

Rear drive motor

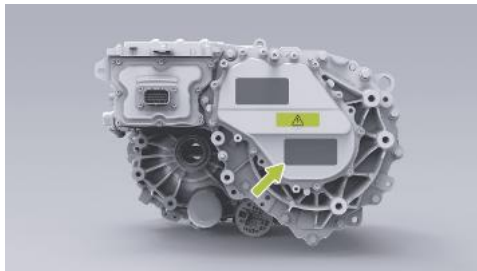

The drive motor model and serial number are displayed on the drive motor housing and the drive motor label.

Parts and Modifications

Introduction

Only genuine XPENG original or approved parts may be used. XPENG has conducted rigorous testing on the parts to ensure their suitability, safety, and reliability. These parts can only be



purchased from XPENG Service Center, installed by XPENG professionals, and vehicles may be modified based on the recommendations of XPENG experts.

Do not modify the vehicle using non-XPENG original or unapproved parts, as this may affect the vehicle's operability, safety, and durability, and may also violate local government regulations.

When modifying the vehicle body (such as applying color-changing film, transparent paint protection film, or anti-collision strips), avoid areas with ultrasonic radar, SRR, AVM cameras, and high-perception cameras, as this may affect the normal operation of related functions such as driver assistance.

The SRR is located inside the front and rear bumpers. Painting, adding trims, or other modifications to the front and rear bumpers without permission is prohibited, as this may affect the normal operation of related functions such as driver assistance.

It is forbidden to replace, modify or add radars or cameras without permission. Otherwise, it may affect the normal operation of related functions such as driver assistance and may also cause radio interference. XPENG assumes no responsibility for any direct or indirect loss caused as a result. In case of any radar or camera fault, please visit XPENG Service Center for repairs.

Do not modify the vehicle's suspension or brake systems, as this may adversely affect the vehicle's handling and safety.

It is forbidden to modify the fuse box of the vehicle, otherwise it may adversely affect the electrical system of the vehicle.

Modifications to electronic components, software, or wiring can affect the functionality and normal operation of related components, particularly safety-related systems, thereby impacting vehicle operation and increasing the risk of accidents or injury.



Therefore, do not modify the wiring, electronic components, or their software.

In addition, damage to the vehicle or performance issues caused by the use of non-XPENG original or unapproved parts for replacement, installation, or modification are not covered under warranty. XPENG assumes no responsibility for any direct or indirect losses caused as a result.

Recycling Requirements and Procedures of Traction Battery

Introduction

When the traction battery needs replacement or disposal, please ensure to contact the XPENG Service Center for recycling and handling. Improper disposal of the traction battery may cause environmental pollution or safety hazards, and the vehicle owner shall bear the corresponding responsibility.

Microwave Window

Introduction



The microwave window is located on the windshield.

warning

- Microwave window position blocking.
- Select the location around the microwave window when attaching the necessary markings for traffic regulations.